



HEIDENHAIN



TNC 640 HSCI

For 1xx Inverter Systems

The Contouring Control for
Milling Machines, Milling-Turning
Machines, and Machining
Centers

**Information for the
Machine Tool Builder**

TNC contouring control with drive system from HEIDENHAIN

General information

TNC 640

- Contouring control for **milling machines, milling-turning machines, and machining centers**
- Axes: up to 24 control loops (22 control loops with functional safety (FS)), of which up to 4 can be configured as spindles
- For operation with HEIDENHAIN inverter systems and ideally HEIDENHAIN motors
- Uniformly digital with HSCI interface and EnDat interface
- Version with touchscreen for multitouch operation
- Solid state disk (SSDR)
- Programming in HEIDENHAIN Klartext or G-code (ISO)
- Comprehensive cycle package for milling and turning operations
- Constant surface speed for turning operations
- Tool radius compensation
- Touch probe cycles
- Free contour programming (FK)
- Special function for fast 3-D machining
- Short block processing time (0.5 ms)

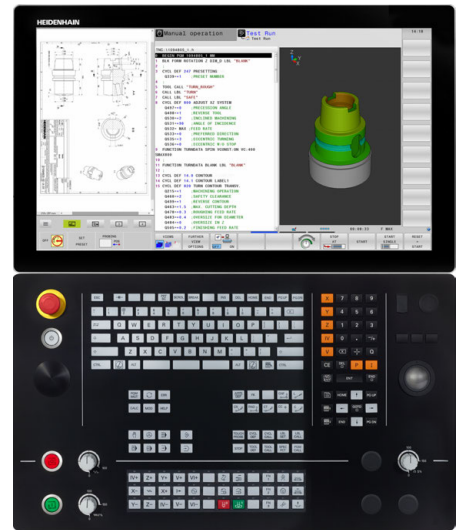

System test

Controls, power modules, motors, and encoders from HEIDENHAIN are usually integrated as components into complete systems. In such cases, comprehensive testing of the complete system is required, irrespective of the specifications of the individual devices.

Parts subject to wear

Controls from HEIDENHAIN contain parts subject to wear, such as a hard disk, backup battery and fan.

Standards

Standards (ISO, EN, etc.) apply only where explicitly stated in the brochure.

Note

Microsoft, Windows 8, Windows 10, and Internet Explorer are registered trademarks of Microsoft Corporation. Intel, Intel Core, and Celeron are registered trademarks of Intel Corporation.

Validity

The features and specifications described here apply to the following control and NC software versions:

TNC 640 with NC software versions
340590-10 (export license required)
340591-10 (no export license required)

This brochure supersedes all previous editions, which thereby become invalid. **Subject to change without notice.**

Requirements

Some of these specifications require particular machine configurations. Please also note that, for some functions, a special PLC program must be created by the manufacturer.

Functional safety (FS)

If no explicit distinction is made between standard and FS components (FS = functional safety), then the data and other information apply to both versions (e.g., TE 745, TE 745 FS).

Use of this brochure

The purpose of this brochure is to help you select suitable components from HEIDENHAIN. Further documents are required for project planning (see "Technical documentation", Page 127).

Contents

TNC contouring control with drive system from HEIDENHAIN	2
Overview tables	4
HSCI control components	16
Accessories	33
Cable overview	51
Technical description	57
Data transfer and communication	92
Mounting information	96
Overall dimensions	98
General information	127
Other HEIDENHAIN controls	129
Subject index	130

Please refer to the **page references** in the **tables** with the specifications.

Overview tables

Components

Control systems		15-inch design	19-inch design	24-inch design	Page
Main computer	<i>For operating panel</i>	MC 8512 MC 7522	MC 8532	MC 366	16
	<i>For electrical cabinet</i>	MC 6541, MC 6542, or MC 6641		–	
Storage medium	<i>MC 85x2</i> <i>MC 75x2</i> <i>MC 6x42</i> <i>MC 306</i>	SSDR solid state disk			18
	<i>MC 6x41</i>	HDR hard disk		–	
NC software license		On SIK component			18
Monitor		BF 750	BF 860	–	27
Keyboard		TE 730 or TE 735	TE 745	TE 360	27
Machine operating panel		MB 720 (integrated in TE 735)	Integrated in TE 745	Integrated in TE 360	28
		MB 721 (for MC 8512)			
		PLB 600x (HSCI adapter for OEM machine operating panel)			
Controller unit	6 control loops	CC 6106			22
	8 control loops	CC 6108			22
	10 control loops	CC 6110			22
	12 control loops	CC 6106 + CC 6106			22
	14 control loops	CC 6108 + CC 6106			22
	16 control loops	CC 6108 + CC 6108			22
	18 control loops	CC 6106 + CC 6106 + CC 6106 or CC 6110 + CC 6108			22
	20 control loops	CC 6110 + CC 6110			22
Power supply^{*)}		PSL 130 / PSL 135			33
PLC inputs/ outputs¹⁾	With HSCI interface	PL 6000 consisting of PLB 62xx basic module (system PL) or PLB 61xx (expansion PL) and I/O modules			31
		On UEC			23
		On UMC			25
Additional modules¹⁾		CMA-H for analog axes/spindles in the HSCI system			35
		Modules for fieldbus systems			
Inverter systems		Compact inverters and modular inverters			*)
Inverters with integrated controller unit	4 control loops	UEC 111			23
		UMC 111			25
	5 control loops	UEC 112			23
	6 control loops	UEC 113			
Connecting cables					51

*) For more information, refer to the *Inverter Systems for HEIDENHAIN Controls* brochure

1) May be necessary depending on the configuration

Please note: The MC main computer does not have any PLC inputs/outputs. Therefore one PL 6000, UEC, or UMC is necessary for each control. They feature safety-relevant inputs/outputs as well as the connections for touch probes.

Accessories

Accessory	TNC 640	Page
Electronic handwheels	<ul style="list-style-type: none"> • HR 510 FS portable handwheel, or • HR 520 FS portable handwheel with display, or • HR 550 FS portable wireless handwheel with display, or • HR 130 panel-mounted handwheel 	38
Workpiece touch probes	<ul style="list-style-type: none"> • TS 260 touch trigger probe with cable connection, or • TS 460 touch trigger probe with radio and infrared transmission, or • TS 740 touch trigger probe with infrared transmission 	36
Tool touch probes	<ul style="list-style-type: none"> • TT 160 touch trigger probe with cable connection, or • TT 460 touch trigger probe with radio and infrared transmission 	37
Programming station¹⁾	Control software for PCs for programming, archiving, and training <ul style="list-style-type: none"> • Single-station license with original control keyboard • Single-station license with virtual keyboard • Network license with virtual keyboard • Demo version with virtual keyboard or PC keyboard—free of charge 	
Auxiliary axis control	PNC 610	43
Industrial PC	ITC 755 : additional operating station with touchscreen and ASCII keyboard ITC 750/ITC 860 : additional operating station; separate TE 7xx necessary IPC 6641 : industrial PC for Windows IPC 6490/IPC 8420 : industrial PC for PNC 610	41
Camera system	VS 101 camera system for monitoring the working space	46
Snap-on keys	For controls and handwheels	47

¹⁾ For more information, refer to the *Programming Station for TNC Controls* brochure

Accessories / Software	TNC 640	Page
PLCdesign¹⁾	PLC development software	88
KinematicsDesign¹⁾	Software for creation of kinematic models	80
M3D Converter⁴⁾	Software for creation of high-resolution collision objects in M3D format	80
TNCremo²⁾, TNCremoPlus²⁾	Data transfer software (TNCremoPlus with “live” screen)	93
ConfigDesign¹⁾	Software for configuring the machine parameters	84
CycleDesign¹⁾	Software for creating cycle structures	91
TNCkeygen¹⁾	Software for enabling SIK options for a limited time, and for single-day access to the OEM area	18
TNCscope¹⁾	Software for data recording	85
TNCopt¹⁾	Software for putting digital control loops into service	85
IOconfig¹⁾	Software for configuring PLC I/O and fieldbus components	32
TeleService¹⁾³⁾	Software for remote diagnostics, monitoring, and operation	86
RemoTools SDK¹⁾	Function library for developing customized applications for communication with HEIDENHAIN controls	94
virtualTNC¹⁾³⁾	Control component for virtual machines	94
TNCtest¹⁾	Software for creation and execution of an acceptance test	86
TNCanalyzer¹⁾	Software for the analysis and evaluation of service files	86

¹⁾ Available to registered customers for download from the Internet

²⁾ Available to all customers (without registration) for download from the Internet

³⁾ Software release module required

⁴⁾ Included in the KinematicsDesign installation package with version 3.1 or later (software release module required)

Specifications

Specifications	TNC 640	Page
Axes	Max. of 24 control loops (22 control loops with functional safety (FS)), of which up to 4 can be configured as spindles	63
Rotary axes	Max. 3	
Synchronized axes	✓	
PLC axes	✓	
Main spindles	<i>Milling</i> : max. 4; second, third, and fourth spindle can be controlled alternately with the first <i>Turning</i> : max. 2 Milling spindle or lathe spindle activated via NC command	69
Speed	Max. 60 000 rpm (with software option 49, max. 120 000 rpm)*	69
Operating mode switchover	✓	69
Position-controlled spindle	✓	69
Oriented spindle stop	✓	69
Gear shifting	✓	69
NC program memory	MC 6x41: ≈ 144 GB on HDR hard disk MC 6542, MC 75x2, MC 85x2: ≈ 21 GB on SDDR solid state disk	16
Input resolution and display step		63
Linear axes	Down to 0.01 μm	
Rotary axes	Down to 0.000 01°	
Functional safety (FS)	With FS components, SPLC, and SKERN	59
For applications with up to	<ul style="list-style-type: none"> • SIL 2 as per EN 61508 • Category 3, PL d as per EN ISO 13849-1: 2008 	
Interpolation		
Straight line	In 4 axes; in max. 6 axes with software option 9	
Circular	In 2 axes; in 3 axes with software option 8	
Helical	✓	
Axis feedback control		71
With following error	✓	
With feedforward	✓	
Axis clamping	✓	63
Maximum feed rate	$\frac{60000 \text{ rpm}}{\text{No. of motor pole pairs}} \cdot \text{Screw pitch [mm]}$ at $f_{\text{PWM}} = 5000 \text{ Hz}$	63

* For motors with a single pole pair

Specifications	TNC 640		Page
Cycle times of main computer	MC		72
Block processing	0.5 ms		73
Cycle times of controller unit	CC/UEC/UMC		72
Path interpolation	3 ms		72
Fine interpolation	<i>Single-speed:</i> 0.2 ms <i>Double-speed:</i> 0.1 ms (software option 49)		
Position controller	<i>Single-speed:</i> 0.2 ms <i>Double-speed:</i> 0.1 ms (software option 49)		
Speed controller	<i>Single-speed:</i> 0.2 ms <i>Double-speed:</i> 0.1 ms (software option 49)		
Current controller	f_{PWM} 3333 Hz 4000 Hz 5000 Hz 6666 Hz with software option 49 8 000 Hz with software option 49 10 000 Hz with software option 49	T_{INT} 150 μs 125 μs 100 μs 75 μs with software option 49 62.5 μs with software option 49 50 μs with software option 49	
Permissible temperature range	Operation: In electrical cabinet: 5 °C to 40 °C In operating panel: 0 °C to 50 °C Storage: -20 °C to 60 °C		

Interfacing to the machine

Interfacing to the machine	TNC 640	Page
Error compensation	✓	81
Linear axis error	✓	81
Nonlinear axis error	✓	81
Backlash	✓	81
Reversal spikes during circular movement	✓	81
Hysteresis	✓	81
Thermal expansion	✓	81
Static friction	✓	81
Sliding friction	✓	81
Integrated PLC	✓	87
Program format	Statement list	87
Program input at the control	✓	87
Program input via PC	✓	87
Symbolic PLC-NC interface	✓	87
PLC memory	> 1 GB	87
PLC cycle time	9 ms to 30 ms (adjustable)	87
PLC inputs/outputs	For the maximum configuration of the PLC system, see Page 58	31, 23
PLC inputs, DC 24 V	Via PL, UEC, UMC	31
PLC outputs, DC 24 V	Via PL, UEC, UMC	31
Analog inputs ± 10 V	Via PL	31
Inputs for PT 100 thermistors	Via PL	31
Analog outputs ± 10 V	Via PL	31
PLC functions	✓	87
Small PLC window	✓	88
PLC soft keys	✓	88
PLC positioning	✓	88
PLC basic program	✓	90
Integration of applications		89
High-level language programming	Use of the Python programming language in conjunction with the PLC (software option 46)	89
User interfaces can be custom-designed	Creation of individualized user interfaces by the machine manufacturer with the Python programming language. Programs up to a memory limit of 10 MB are enabled in standard mode. More can be enabled via software option 46.	89

Interfacing to the machine	TNC 640	Page
Commissioning and diagnostic aids		84
DriveDiag	Software for diagnosis of digital drive systems	84
TNCOpt	Software for putting digital control loops into service	85
ConfigDesign	Software for creating the machine configuration	84
KinematicsDesign	Software for creating the machine kinematics, initialization of DCM	80
Integrated oscilloscope	✓	84
Trace function	✓	85
API DATA function	✓	85
Table function	✓	85
OLM (online monitor)	✓	85
Log	✓	85
TNCscope	✓	85
Bus diagnostics	✓	86
Data interfaces	✓	
Ethernet	2 x 1000BASE-T	92
USB	Rear: 4 x USB 3.0 Front: may vary based on the component description	92
V.24/RS-232-C	✓	92
Protocols		92
Standard data transmission	✓	92
Blockwise data transfer	✓	92
LSV2	✓	92

Encoder inputs		CC 6106	CC 6108	CC 6110	UEC 111	UMC 111	UEC 112	UEC 113	70
Position		6	8	10	4	-	5	6	70
	Incremental	1 V _{PP}							70
	Absolute	EnDat 2.2							70
Speed		6	8	10	4	4	5	6	70
	Incremental	1 V _{PP}							70
	Absolute	EnDat 2.2							70
Nominal-value outputs		CC 6106	CC 6108	CC 6110	UEC 111	UMC 111	UEC 112	UEC 113	70
PWM		6	8	10	-	-	-	-	
Motor connections		-	-	-	4	4	5	6	

User functions

User function	Standard	Option	TNC 640
Short description	✓	0-7 77 78	Basic version: 3 axes plus closed-loop spindle A total of 14 additional NC axes or 13 additional NC axes plus second spindle
	✓		Digital current and speed control
Program entry	✓ ✓	42	HEIDENHAIN Klartext According to ISO Direct loading of contours or machining positions from DXF files and saving as Klartext contouring programs, or as point tables
Position values	✓ ✓ ✓		Nominal positions for lines and arcs in Cartesian coordinates or polar coordinates Incremental or absolute dimensions Display and entry in mm or inches
Tool compensation	✓ ✓	9	Tool radius in the working plane and tool length Radius-compensated contour look ahead for up to 99 blocks (M120) Three-dimensional tool-radius compensation for changing tool data without having to recalculate an existing program
Tool tables	✓		Multiple tool tables with any number of tools
Cutting data	✓		Automatic calculation of spindle speed, cutting speed, feed per tooth, and feed per revolution
Constant contour speed	✓ ✓		Relative to the path of the tool center Relative to the tool's cutting edge
Parallel operation	✓		Creating a program with graphical support while another program is being run
3-D machining	✓	9 9 9 9 9 92	Motion control with smoothed jerk 3-D tool compensation via surface-normal vectors Using the electronic handwheel to change the angle of the swivel head during program run without affecting the position of the tool point (TCPM = Tool Center Point Management) Keeping the tool normal to the contour Tool radius compensation normal to the tool direction Manual traverse in the active tool-axis system 3-D radius compensation depending on the tool's contact angle
Rotary table machining		8 8	Programming of cylindrical contours as if in two axes Feed rate in mm/min
Turning		50 50 50 50 50 50 50 50 50 50 50	Program-controlled switchover between milling and turning Constant surface speed Tool radius compensation Cycles for roughing, finishing, recessing, thread turning, and recess turning Blank form updated in contour cycles Turning-specific contour elements for recesses and undercuts Orientation of the turning tool for outside or inside machining Inclined turning Speed limiting Eccentric turning (also requires software option 135)
Contour elements	✓ ✓ ✓ ✓ ✓ ✓ ✓	50 50	Straight line Chamfer Circular path Circle center Circle radius Tangentially connecting circular arc Corner rounding Recess Undercut

User function	TNC 640	
	Standard	Option
Contour approach and departure	✓ ✓	Via straight line: tangential or perpendicular Via circular arc
Adaptive feed control		45 AFC: Adaptive Feed Control adjusts the contouring feed rate to the current spindle power
Collision monitoring		40 Dynamic Collision Monitoring (DCM) 40 Graphic depiction of the active collision objects (high-resolution M3D format) 40 Tool carrier monitoring
FK free contour programming	✓	FK free contour programming in HEIDENHAIN Klartext format with graphical support for workpiece drawings not dimensioned for NC
Program jumps	✓ ✓ ✓	Subprograms Program section repeat Calling any program as a subprogram
Fixed cycles	✓ ✓ 50 50 50 ✓ 50 50+ 135 96 ✓ ✓ ✓ ✓ ✓ ✓ ✓ ✓ ✓	Drilling, tapping with a floating tap holder, rigid tapping Peck drilling, reaming, boring, counterboring, centering Area clearance cycles, longitudinal and transverse, paraxial and contour parallel Recessing cycles, radial/axial Radial/axial recess turning cycles (combined recessing and roughing motion) Milling internal and external threads Turning internal and external threads Hobbing Interpolation turning (not with functional safety (FS)) Clearing level and oblique surfaces Multi-operation machining of straight and circular slots Multi-operation machining of rectangular and circular pockets Point patterns for circles, lines, and DataMatrix codes Contour train, contour pocket Contour slot with trochoidal milling OEM cycles (special cycles developed by the machine tool builder) can be integrated Engraving cycle: engrave text or numbers in a straight line or on an arc
Coordinate transformations	✓	8 Shifting, rotating, mirroring, scaling (axis specific) 44 Tilting the working plane, PLANE function <i>Manually definable</i> : shifts, rotations, and handwheel superimpositioning can be manually defined via global program settings
Q parameters Programming with variables	✓ ✓ ✓ ✓ ✓ ✓	Mathematical functions =, +, -, *, /, sin α, cos α, tan α, arc sin, arc cos, arc tan, a^n , e^n , ln, log, square root of a , square root of $(a^2 + b^2)$ Logical operations (=, ≠, <, >) Calculating with parentheses Absolute value of a number, constant π, negation, truncation of digits before or after the decimal point Functions for calculation of circles Functions for text processing
Programming aids	✓ ✓ ✓ ✓ ✓ ✓	Calculator Complete list of all current error messages Context-sensitive help function for error messages TNCguide: the integrated help system. User information directly available on the TNC 640; context-sensitive calling possible Graphic support for programming cycles Comment and structure blocks in the NC program
CAD viewer	✓	Display of standardized CAD file formats on the TNC

User function	TNC 640	
	Standard	Option
Teach-In	✓	
Test graphics Depictions	✓ ✓ ✓	
3-D line graphics	✓	
Programming graphics	✓	
Program-run graphics Display modes	✓ ✓	
Machining time	✓ ✓	
Returning to the contour	✓ ✓	
Preset management	✓	
Datum tables	✓	
Pallet tables	✓	
Parallel secondary axes	✓ ✓ ✓	
Touch probe cycles	✓ ✓ ✓ ✓	48
Conversational languages	✓	

Software options

Software option number	Software option	With NC software 34059x- or later	ID	Comment	Page
0	Additional Axis 1	01	354540-01	Additional control loop 1	20
1	Additional Axis 2	01	353904-01	Additional control loop 2	20
2	Additional Axis 3	01	353905-01	Additional control loop 3	"Enabling further control loops"
3	Additional Axis 4	01	367867-01	Additional control loop 4	"Enabling further control loops"
4	Additional Axis 5	01	367868-01	Additional control loop 5	20
5	Additional Axis 6	01	370291-01	Additional control loop 6	20
6	Additional Axis 7	01	370292-01	Additional control loop 7	20
7	Additional Axis 8	01	370293-01	Additional control loop 8	20
8	Advanced Function Set 1	01	617920-01	Rotary table machining <ul style="list-style-type: none"> • Programming of cylindrical contours as if in two axes • Feed rate in mm/min 	63
				Coordinate transformation <ul style="list-style-type: none"> • Tilting the working plane, PLANE function 	64
				Interpolation <ul style="list-style-type: none"> • Circular in 3 axes with tilted working plane 	
9	Advanced Function Set 2	01	617921-01	3-D machining <ul style="list-style-type: none"> • 3-D tool compensation via surface normal vectors • Using the electronic handwheel to change the angle of the swivel head during program run without affecting the position of the tool point (TCPM = Tool Center Point Management) • Keeping the tool normal to the contour • Tool radius compensation normal to the tool direction • Manual traverse in the active tool-axis system Interpolation <ul style="list-style-type: none"> • Linear in more than 4 axes (export license required) 	64
18	HEIDENHAIN DNC	01	526451-01	Communication with external PC applications over COM component	94
40	DCM Collision	01 02	526452-01	Dynamic collision monitoring (DCM)	79
42	CAD Import	08	526450-01	Importing of contours from 2-D and 3-D models, e.g., STEP, IGES, DXF	
44	Global PGM Settings	05	576057-01	Global program settings	65
45	Adaptive Feed Control (AFC)	02	579648-01	Adaptive feed control	74
46	Python OEM Process	01	579650-01	Execute Python applications	89
48	KinematicsOpt	01	630916-01	Touch-probe cycles for the automated measurement of rotary axes	82
49	Double-Speed Axes	01	632223-01	Short control-loop cycle times for direct drive motors	72

Software option number	Software option	With NC software 34059x- or later	ID	Comment	Page
50	Turning	01	634608-01	Turning functions <ul style="list-style-type: none"> • Tool management for turning • Tool-tip radius compensation • Switching between milling and turning modes of operation • Lathe-specific contour elements • Package of turning cycles 	66
52	KinematicsComp	05	661879-01	Spatial compensation of errors in rotary and linear axes (export license required)	83
56 - 61	OPC UA NC Server 1 to 6	10	1291434-01 to 1291434-06	Connection of an OPC UA application	95
77	4 Additional Axes	01	634613-01	4 additional control loops	20
78	8 Additional Axes	01	634614-01	8 additional control loops	20
92	3D-ToolComp	07	679678-01	3-D radius compensation based on the contact angle (only with the Advanced Function Set 2 software option)	83
93	Extended Tool Management	01	676938-01	Expanded tool management: <ul style="list-style-type: none"> • Tooling list (list of all tools of the NC program) • T usage sequence (sequence of all tools inserted during the program) 	
96	Adv. Spindle Interp.	05	751653-01	Additional functions for an interpolated spindle <ul style="list-style-type: none"> • Interpolation turning, coupling • Interpolation turning, contour finishing 	
101 - 130	OEM Software Option	02	579651-01 to 579651-30	Software options of the machine manufacturer	
131	Spindle Synchronism	05	806270-01	Synchronization of two or more spindles	94
133	Remote Desktop Manager	01	894423-01	Display and remote operation of external computer units (e.g., a Windows PC)	94
135	Synchronizing Functions	04	1085731-01	Expanded synchronization of axes and spindles	65
136	Visual Setup Control	06	1099457-01	VSC: camera-based monitoring of the setup situation	65
137	State Reporting	09	1232242-01	State Reporting Interface (SRI): provision of operating statuses	86
141	Cross Talk Comp.	02	800542-01	CTC: compensation of axis couplings	77
142	Pos. Adapt. Control	02	800544-01	PAC: position-dependent adaptation of control parameters	77
143	Load Adapt. Control	02	800545-01	LAC: load-dependent adaptation of control parameters	76
144	Motion Adapt. Control	02	800546-01	MAC: motion-dependent adaptation of control parameters	76
145	Active Chatter Control	02	800547-01	ACC: active suppression of chatter	75

Software option number	Software option	With NC software 34059x- or later	ID	Comment	Page
146	Active Vibration Damping	04	800548-01	AVD: active vibration damping	77
154	Batch Process Manager	05	1219521-01	Planning and executing multiple machining operations	65
155	Component Monitoring	09	1226833-01	Monitoring for component overloading and wear	80
156	Grinding	10	1237232-01	Grinding function <ul style="list-style-type: none"> • Jig grinding • Switching between normal operation and dressing mode • Reciprocating stroke • Grinding cycles • Tool management for grinding and dressing 	68
157	Gear Cutting	09	1237235-01	Functions for the machining of gear teeth	67
158	Advanced Function Set Turning	09	1237237-01	Extended turning cycles and functions	67
167	Optimized Contour Milling	10	1289547-01	OCM: optimized contour milling	75

HSCI control components

Main computers

Main computer

The **MC** main computers feature:

- Processor
- RAM memory
- HSCI interface to the controller unit and to other control components
- HDL interface to the BF monitor (with electrical cabinet versions)
- 4 x USB 3.0 interface, e.g. to the TE 7x5 keyboard unit

To be ordered separately, and installed in the main computer by the OEM:

- **HDR** or **SSDR** storage medium with the NC software
- The **System Identification Key** (SIK) component for enabling control loops and software options.

The following HSCI components are necessary for operation of the TNC 640:

- MC main computer
- Controller unit
- **PLB 62xx** PLC I/O unit (system PL; integrated in UxC)
- **MB 72x** machine operating panel (integrated in TE 7x5) or **PLB 600x** HSCI adapter for connection of an OEM machine operating panel

Interfaces

For use by end users, the MC is equipped with the USB 3.0, V.24/RS-232-C and Ethernet interfaces. Connection to PROFIBUS DP or PROFINET IO is possible either via additional modules or by means of a combined PROFIBUS DP / PROFINET IO module.

Power supply

The DC 24 V supply voltage to the main computer and other HSCI components is provided by the PSL 13x power supply unit with the supply voltage 24 V-NC or by the power supply of a UEC compact inverter. For the entire HSCI system, this DC 24 V-NC supply voltage is required to be safely separated voltage (PELV). It must not be connected to the DC 24 V supply voltage for PLC components (e.g., holding brakes).

Export version

Because the complete NC software is on the storage medium, no export version is required for the main computer itself. Only the easily replaceable storage medium and SIK component are available as export versions.

Gen 3 labels

The Gen 3 labels identify in which systems the control components can be used.

Gen³ ready

Gen 3 ready: These components can be used in systems with Gen 3 drives (UVR 3xx, UM 3xx, CC 3xx) and in systems with a 1xx inverter system (UVR 1xx, UE 2xx, UR 2xx, CC 61xx).

Versions

Various versions of the MC main computer are available:

- Installation in the **electrical cabinet**:
The MC 6x4x are installed in the electrical cabinet. The operating panel requires HSCI, USB, and HDL cables as control lines
- Installation in the **operating panel**:
The MC 7522 (with operating keys), as well as the MC 85x2 (with touchscreen), are installed directly into the operating panel. With the exception of the power supply line, only one HSCI connecting cable to the electrical cabinet is needed. These MCs are supported with NC software 34059x-04 or later



MC 6x41



MC 654x

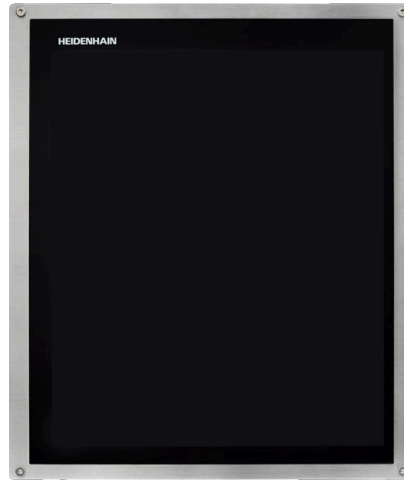

MC 8512 with main computer installed on the back



MC 8532 with main computer installed on the back

	Installation type	Storage medium	Processor	RAM memory	Power consumption*	Mass	ID
MC 6541	Electrical cabinet	HDR	Intel Core i7-3 1.7 GHz, dual-core	4 GB	≈ 48 W	≈ 4.0 kg	1081185-xx
MC 6542	Electrical cabinet	SSDR	Intel Core i7-3 1.7 GHz, dual-core	4 GB	≈ 48 W	≈ 4.0 kg	1081188-xx
MC 6641	Electrical cabinet	HDR	Intel Core i7-3 2.1 GHz, quad-core	4 GB	≈ 75 W	≈ 4.0 kg	811550-xx
MC 7522	Operating panel	SSDR	Intel Core i7-3, 1.7 GHz, dual-core	4 GB	≈ 60 W	≈ 6.5 kg	1071597-xx
MC 8512	Operating panel	SSDR	Intel Core i7-3 1.7 GHz, dual-core	4 GB	≈ 75 W	≈ 7.5 kg	1243919-xx
MC 8532	Operating panel	SSDR	Intel Core i7-3 1.7 GHz, dual-core	4 GB	≈ 75 W	≈ 7.5 kg	1189190-xx
MC 366	Operating panel	SSDR	Intel Core i7-3, 1.7 GHz, dual-core	8 GB	≈ 75 W	≈ 7.5 kg	1246689-xx

* Test conditions: Windows 7 (64-bit) operating system, 100 % processor loading, no load on interfaces, no fieldbus module

Software options

Software options allow the performance of the TNC 640 to be adapted to one’s actual needs at a later time. The software options are described on page 13. They are enabled by entering keywords based on the SIK number and are saved in the SIK component. Please provide the SIK number when ordering new options.

Storage medium

The storage medium must be ordered separately. It is removable memory and contains the NC software. Depending on the main computer, an HDR hard disk or an SSDR solid state disk is used as a storage medium.

HDR hard disk

Free capacity	144 GB
For main computer	MC 6541, MC 6641
Export license required	ID 617779-10
No export license required	ID 617779-60

SSDR solid state disk

Free capacity	21 GB
For main computer	MC 6542, MC 7522, MC 85x2
Export license required	ID 810288-10
No export license required	ID 810288-60

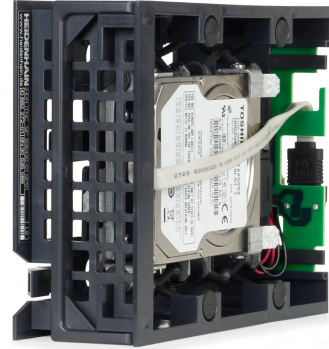

HDR hard disk

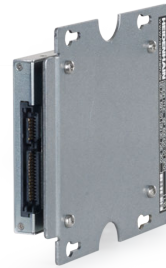

SSDR solid state disk

SIK component

The SIK component contains the **NC software license** for enabling control loops and software options. It gives the main computer an unambiguous ID code—the SIK number. The SIK component is ordered and shipped separately. It must be inserted into a slot provided for it in the MC main computer.

The SIK component with the NC software license exists in different versions based on the enabled control loops and software options. Additional control loops can be enabled later by entering a keyword. HEIDENHAIN provides the keyword, which is based on the SIK number.

When ordering, please provide the SIK number of your control. When the keywords are entered in the control, they are saved in the SIK component, thereby enabling and activating the software options. Should servicing become necessary, the SIK component must be inserted into the replacement control in order to enable all of the required software options.

Master keyword (general key)

For putting the TNC 640 into service, there is a master keyword that enables all software options once for 90 days. After this period, the software options can be activated only with the correct keywords. The general key is activated via a soft key.

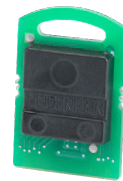

SIK component

**TNCkeygen
(accessory)**

TNCkeygen is a collection of PC software tools for generating enabling keys for HEIDENHAIN controls for a limited period of time.

With **OEM Key Generator**, you can generate enabling keys for software options by entering the SIK number, the software option to be enabled, the enabling period, and an OEM-specific password. The enabling period is limited to 10 to 90 days. Each software option can be enabled only once. Options are enabled independently of the master keyword.

The **OEM daily key generator** generates an enabling key for the protected OEM area, thus granting the user access on the day it is generated.

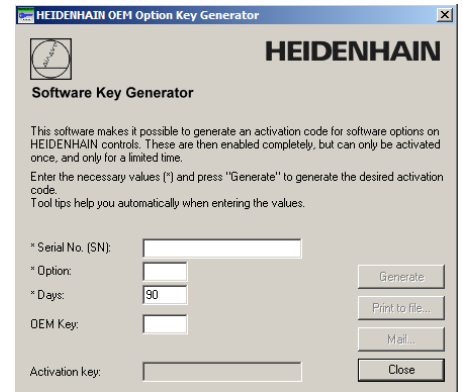

NC software license and enabling of control loops depending on the CC

Active control loops	Recommended combinations						NC software license			
	CC 6106	CC 6108	CC 6110	2 x CC 6106	CC 6106 + CC 6108	2 x CC 6108	Without option	Incl. option 8	Incl. options 8 + 9	Incl. options 8 + 9 + 50
							SIK	SIK	SIK	SIK
4	✓						ID 674989-20 <i>ID 674989-70</i>	ID 674989-09 <i>ID 674989-59</i>	ID 674989-01 <i>ID 674989-51</i>	ID 674989-28 <i>ID 674989-78</i>
5	✓						ID 674989-24 <i>ID 674989-74</i>	ID 674989-17 <i>ID 674989-67</i>	ID 674989-02 <i>ID 674989-52</i>	ID 674989-29 <i>ID 674989-79</i>
6	✓						ID 674989-25 <i>ID 674989-75</i>	ID 674989-18 <i>ID 674989-68</i>	ID 674989-03 <i>ID 674989-53</i>	ID 674989-30 <i>ID 674989-80</i>
7		✓					ID 674989-26 <i>ID 674989-76</i>	ID 674989-19 <i>ID 674989-69</i>	ID 674989-04 <i>ID 674989-54</i>	ID 674989-31 <i>ID 674989-81</i>
8		✓					ID 674989-27 <i>ID 674989-77</i>	ID 674989-23 <i>ID 674989-73</i>	ID 674989-05 <i>ID 674989-55</i>	ID 674989-32 <i>ID 674989-82</i>
9			✓				Only through subsequent enabling of control loops (additional axes)		ID 674989-06 <i>ID 674989-56</i>	ID 674989-33 <i>ID 674989-83</i>
10			✓					ID 674989-07 <i>ID 674989-57</i>	ID 674989-34 <i>ID 674989-84</i>	
11				✓				ID 674989-10 <i>ID 674989-60</i>	ID 674989-35 <i>ID 674989-85</i>	
12				✓				ID 674989-11 <i>ID 674989-61</i>	ID 674989-36 <i>ID 674989-86</i>	
13					✓			ID 674989-12 <i>ID 674989-62</i>	ID 674989-37 <i>ID 674989-87</i>	
14					✓			ID 674989-13 <i>ID 674989-63</i>	ID 674989-38 <i>ID 674989-88</i>	
15						✓		ID 674989-14 <i>ID 674989-64</i>	ID 674989-39 <i>ID 674989-89</i>	
16						✓		ID 674989-15 <i>ID 674989-65</i>	ID 674989-40 <i>ID 674989-90</i>	
17 – 24							Only through subsequent enabling of control loops (additional axes)			

(Italics: export version)

Enabling further control loops

Further control loops can be enabled either as groups or individually. The combination of control-loop groups and individual control loops makes it possible to enable any number of control loops. No more than **24 control loops** are possible.

Control-loop groups	Software option	
4 additional control loops	77	ID 634613-01
8 additional control loops	78	ID 634614-01

Individual control loops	Software option	
1st additional control loop	0	ID 354540-01
2nd additional control loop	1	ID 353904-01
3rd additional control loop	2	ID 353905-01
4th additional control loop	3	ID 367867-01
5th additional control loop	4	ID 367868-01
6th additional control loop	5	ID 370291-01
7th additional control loop	6	ID 370292-01
8th additional control loop	7	ID 370293-01

Controller unit

Controller unit Due to the very short cycle times of the position, speed, and current controllers, the controller units from HEIDENHAIN are equally suited for conventional motors, for direct drive motors (linear motors, torque motors), and for HSC spindles. They permit a high loop gain and short reaction times to changing machining forces, and so make the high contour accuracy and surface quality of the workpiece possible.

Single-speed
Double-speed For linear and torque motors, as well as for conventional axes, **single-speed control loops** are usually sufficient. For HSC spindles and difficult-to-control axes, **double-speed control loops** are the preferred choice (software option 49). By default, all axes are set to single-speed. Every axis that is switched from single-speed to double-speed can reduce the number of available control loops by one. At a PWM frequency greater than 5 kHz, double-speed is always required. Software option 49 must be enabled for this.

Cycle times	At f_{PWM}	Current controller	Speed controller		Position controller
			Single-speed	Double-speed ¹⁾	
	3333 Hz	150 μs	300 μs	150 μs	Same as speed controller
	4000 Hz	125 μs	250 μs	125 μs	
	5000 Hz	100 μs	200 μs	100 μs	
	6666 Hz ¹⁾	75 μs	150 μs	150 μs	
	8000 Hz ¹⁾	60 μs	125 μs	125 μs	
	10 000 Hz ¹⁾	50 μs	100 μs	100 μs	

¹⁾ Possible only with software option 49

Number of control loops The number of enabled control loops depends on the SIK (see *Main computers*), or on additionally enabled control loops, which can also be ordered as needed later.

Versions

- Modular CC 61xx controller units with PWM interface to the inverters
- Compact UEC/UMC inverters with integrated controller unit

Controller units, main computers, and inverters operate in any desired combination.

CC 61xx

The **CC 61xx** controller units feature:

- Position controller, speed controller, current controller
- HSCI interfaces
- PWM interfaces to the UM, UR, UE power modules
- Interfaces to the speed and position encoders
- Interfaces for power supply (via inverter or PSL 135)
- SPI interfaces for expansion modules (e.g. CMA-H)

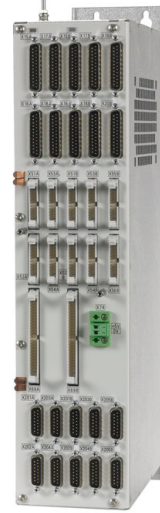

CC 6110

	CC 6106	CC 6108	CC 6110
Digital control loops	Max. 6 (single speed)	Max. 8 (single speed)	Max. 10 (single speed)
Speed inputs	6 x 1 V _{pp} or EnDat 2.2	8 x 1 V _{pp} or EnDat 2.2	10 x 1 V _{pp} or EnDat 2.2
Position inputs	6 x 1 V _{pp} or EnDat 2.2	8 x 1 V _{pp} or EnDat 2.2	10 x 1 V _{pp} or EnDat 2.2
PWM outputs	6	8	10
SPI expansion slots	2	4	4
Power consumption (without encoders)	25 W	35 W	40 W
Mass	4.1 kg	4.7 kg	4.8 kg
	ID 662636-xx	ID 662637-xx	ID 662638-xx

For more than 10 control loops, an HSCI line is used to combine the controller units. For example:

CC 6106 + CC 6106 for up to 12 control loops

CC 6106 + CC 6108 for up to 14 control loops

CC 6110 + CC 6108 for up to 18 control loops

Constraints:

- Up to 24 control loops (22 control loops with functional safety (FS)) can be activated, of which up to 4 can be configured as spindles
- Maximum of 4 controller motherboards are permissible in the HSCI system (CC 6106 contains one motherboard, CC 6108/CC 6110 each have two)

Ribbon cables for supply voltage

Additional ribbon cables are necessary if multiple CC 6xxx units are combined.

Combination	Length	Dimension c	
2 x CC 6108, or 2 x CC 6110, or CC 6108 and CC 6110	160 mm ¹⁾	26.5 mm	ID 325816-22
2 x CC 6106	110 mm	31.5 mm	ID 325816-24

¹⁾ In order to reduce the voltage drop, the long ribbon cable is routed doubled.

With a combination of CC 6108 and/or CC 6110, the short ribbon cables included in delivery are not needed. They are only necessary for connecting sockets X69 A and X69 B if the CC units are used separately.

For more information about connecting a CC 6xxx to a supply unit via ribbon cables, see the *Inverter Systems* brochure.

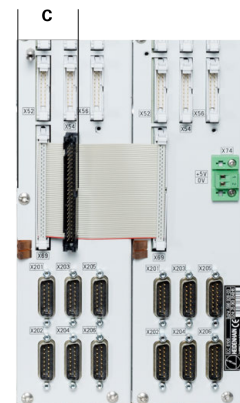
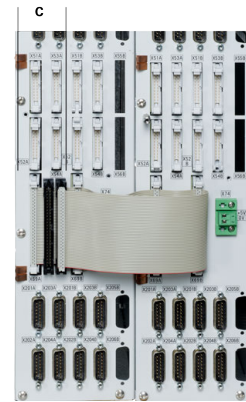

UEC 11x

The UEC 11x compact inverters not only include the inverter, but also a controller with PLC inputs and outputs and an integrated braking resistor. They form a complete solution for machines with a limited number of axes and low power demands.

Controllers

- Position controller, speed controller, current controller
- HSCI interface
- Interfaces to the speed and position encoders
- SPI interface

Inverters

- Power electronics
- Connections for axis motors and spindle motor
- Braking resistor
- Connections for motor holding brakes
- Additional DC-link connection on the front for connection of a PSL 130

System PL (without EnDat support)

- Interfaces for one workpiece touch probe and one tool touch probe
- Integrated PLC (expandable with PL 61xx)
UEC 11x: 38 free inputs, 23 free outputs (7 of which can be switched off)
- Configuration with IOconfig PC software

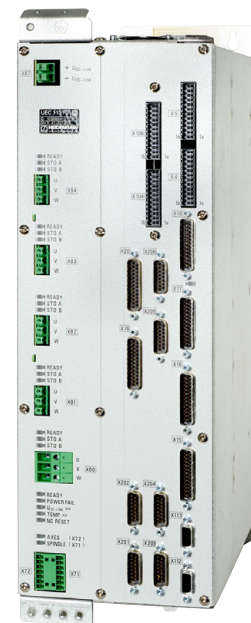

UEC 113

UEC 111/UEC 112/UEC 113

Controllers		4/5/6 digital control loops		
Speed inputs		4/5/6 x 1 V _{pp} or EnDat 2.2		
Position inputs		4/5/6 x 1 V _{pp} or EnDat 2.2		
Inverters		2/3/4 axes	1 axis	Spindle
Rated current I_N/ Maximum current I_{max}¹⁾ at a PWM frequency of	3333 Hz	6.0/12.0 A	9.0/18.0 A	24.0/36.0 A
	4000 Hz	5.5/11.0 A	8.3/16.5 A	22.0/33.0 A
	5000 Hz	5.0/10.0 A	7.5/15.0 A	20.0/30.0 A
	6666 Hz	4.2/8.4 A	6.3/12.6 A	16.8/25.2 A
	8000 Hz	3.6/7.3 A	5.5/11.0 A	14.6/21.9 A
	10 000 Hz	3.0/6.0 A	4.6/9.2 A	12.2/18.3 A
Supply voltage		3AC 400 V (± 10 %); 50 Hz or 3AC 480 V (+6 %/-10 %); 60 Hz		
Rated power of DC link		14 kW		
Peak power²⁾ of DC link		18 kW / 25 kW		
Power loss at I_N		≈ 450 W		
DC-link voltage		DC 565 V		
Integral braking resistance³⁾		2.1 kW / 27 kW		
Power supply unit for HSCI components		DC 24 V / 3.5 A		
Module width		150 mm		
Mass		≈ 14 kg		
Functional safety (FS)		-	✓	
UEC 111		ID 1081002-xx	ID 1075825-xx	
UEC 112		ID 1081003-xx	ID 1075826-xx	
UEC 113		ID 828471-xx	ID 1038694-xx	

1) Axis: 0.2 s cyclic duration factor for cycle duration of 10 s with 70 % rated current preload
Spindle: 10 s cyclic duration factor for cycle duration of 60 s with 70 % rated current preload

2) 1st value: 40 % cyclic duration factor for cycle duration of 10 min (S6-40 %)
2nd value: 4 s cyclic duration factor for cycle duration of 20 s

3) 1st value: continuous power
2nd value: peak power (1.5 % cyclic duration factor for cycle duration of 120 s)

UMC 11x FS

The UMC 111 FS is a compact inverter with an integrated controller unit and PLC inputs/outputs. In contrast to the UEC, it is used exclusively for controlling axis motors and is powered by an external DC link. The UMC automatically enables the control loops needed for auxiliary axes. Additional software options are not necessary.

Please note: The UMC does not expand the number of possible axes. Interpolation with NC axes is not possible.

Controllers

- Position controller, speed controller, current controller
- HSCI interface
- Interfaces to the speed encoders
- SPI interface

Inverters

- Power electronics
- Connections for axis motors
- Connections for motor holding brakes

System PL (without EnDat support)

- Integrated PLC, expandable with PL 61xx
UMC 111 FS: 38 free inputs, 28 free outputs (7 of which can be switched off)
 8 FS inputs, 8 FS outputs
- Configuration with IOconfig PC software

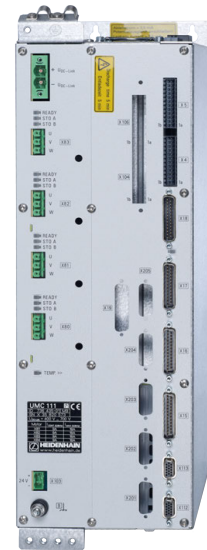

UMC 111 FS

		UMC 111 FS
Controllers		4 digital control loops
Speed inputs		4 x 1 V _{pp} or EnDat 2.2
Inverters		4 axes
Rated current I_N/ Maximum current I_{max}¹⁾ at a PWM frequency of	3333 Hz	9.0/18.0 A
	4000 Hz	8.3/16.5 A
	5000 Hz	7.5/15.0 A
	6666 Hz	6.3/12.6 A
	8000 Hz	5.5/11.0 A
	10 000 Hz	4.6/9.2 A
Power loss at I_N		≈ 300 W
DC-link voltage		DC 565 V or DC 650 V
24 V PLC current consumption		DC 24 V / 2 A
Module width		150 mm
Mass		≈ 11 kg
UMC 111 FS		ID 664231-xx

1) Axis: 0.2 s cyclic duration factor for cycle duration of 10 s with 70 % rated current preload
 Spindle: 10 s cyclic duration factor for cycle duration of 60 s with 70 % rated current preload

Adapter connector for temperature sensor

For applications with purely serial EnDat 2.2 encoders, the adapter connector offers the option of interposing an external KTY or PT 1000 temperature sensor (e.g., of linear and torque motors) and route it to the speed encoder input of the controller unit.

The adapter connector can also be used in conjunction with encoders with EnDat02 or 1 V_{pp} interface. The adapter connector is plugged directly onto the speed encoder input (X15 to X20) of the controller unit.



KTY adapter connector ID 367770-xx
Mass ≈ 0.1 kg

Additional cables are required for the use of multiple adapter connectors on one controller unit because the connector for an external KTY or PT 1000 temperature sensor does not permit the mounting of multiple adapter connectors in a row on the CC 61xx.

	Encoders with EnDat interface (EnDat2.1, EnDat2.2)	Encoders with 1 V_{pp} interface
1 m cable	ID 336377-01	ID 312533-01
3 m cable	ID 336377-03	ID 312533-03

15-inch screen and keyboard

BF 750 monitor

- Supply voltage: DC 24 V/≈ 50 W
- **15-inch**; 1024 x 768 pixels
- HDL interface to the MC 6xxx
- 8 horizontal soft keys, 6 vertical soft keys for PLC
- Soft-key row switchover
- Selectable screen layout
- Operating mode switchover
- USB port with cover cap on front
- Integrated USB hub with four USB interfaces on the rear

BF 750 ID 785080-xx
Mass ≈ 4 kg



BF 750

TE 730 keyboard

Gen3 ready

- For BF 750 or MC 7522
- Axis keys
- The keys for axes IV and V are exchangeable snap-on keys.
- Contouring keys
- Operating mode keys
- ASCII keyboard
- Spindle-speed and feed-rate override potentiometer
- USB interface to the MC
- Touchpad

TE 730 ID 805489-xx
Mass ≈ 2.4 kg



TE 730

TE 735 keyboard with an integrated machine operating panel

Gen3 ready

- For BF 750 or MC 7522
- NC keyboard same as TE 730
- USB interface to the MC main computer
- Machine operating panel (same as MB 720)
- HSCI interface

TE 735 ID 771898-xx
TE 735 FS ID 805493-xx
Mass ≈ 3.4 kg



TE 735

MB 720 machine operating panel

Gen3 ready

- Supply voltage: DC 24 V/≈ 4 W
- 36 exchangeable snap-on keys with status LED, freely definable via PLC (assignment as per PLC basic program: 12 axis keys, spindle start, spindle stop, 22 further function keys)
- Further operating elements: NC start¹⁾, NC stop¹⁾, emergency-stop key, control voltage On¹⁾, two bore holes for additional keys or keylock switches
- HSCI interface
- MB 720: 8 free PLC inputs and 8 free PLC outputs
MB 720 FS: 4 free FS inputs and 8 free PLC outputs; additional dual-channel FS inputs for emergency stop and permissive buttons of the handwheel.

¹⁾ Illuminated keys, addressable via PLC

MB 720 ID 784803-xx

MB 720 FS ID 805474-xx

Mass ≈ 1 kg

MB 721 machine operating panel

Gen3 ready

Same as the MB 720, except:

- Suitable for the MC 8512
- Changed front panel
- Three holes for additional push buttons or keylock switches

MB 721 ID 1164974-xx

MB 721 FS ID 1164975-xx

Mass ≈ 1.6 kg



MB 720



MB 721

19-inch screen and keyboard

BF 860 monitor

- Supply voltage: DC 24 V/≈ 65 W
- **19-inch**; 1280 x 1024 pixels
- Integrated USB hub with 4 USB ports on the rear
- Display for multitouch operation

Via touchscreen operation

- Soft-key row switchover
- Screen layout
- Operating mode switchover

BF 860 ID 1244875-xx
Mass ≈ 7.1 kg



BF 860

TE 745 keyboard with an integrated machine operating panel

Gen3 ready

General data:

- Suitable for BF 860 (19-inch design)
- Axis keys
- The keys for axes IV and V are exchangeable snap-on keys
- Contouring keys
- Operating mode keys
- ASCII keyboard
- Spindle, feed-rate, and rapid-traverse override potentiometers
- USB interface to the MC main computer
- Touchpad
- USB port with cover cap on front

Specifications:

- Supply voltage: DC 24 V/≈ 4 W
- 36 exchangeable snap-on keys with status LED, freely definable via PLC (assignment in accordance with PLC basic program: 12 axis keys, spindle start, spindle stop, 22 other function keys)
- Further operating elements: NC start¹⁾, NC stop¹⁾, emergency-stop key, control voltage on¹⁾, two holes for additional keys or keylock switches
- Connection for HR handwheel
- HSCI interface
- TE 745: 8 free PLC inputs and 8 free PLC outputs
TE 745 FS: 4 free FS inputs and 8 free PLC outputs; additional dual-channel FS inputs for emergency stop and permissive buttons of the handwheel.

¹⁾ Illuminated keys, addressable via PLC

TE 745 ID 679817-xx
TE 745 FS ID 805482-xx
Mass ≈ 4.3 kg



TE 745

24-inch keyboard

TE 360 keyboard with an integrated machine operating panel

Gen3 ready

General data:

- Suitable for BF 360 (24-inch design)
- Axis keys
- The keys for axes IV and V are exchangeable snap-on keys
- Contouring keys
- Operating mode keys
- ASCII keyboard
- Spindle, feed-rate, and rapid-traverse override potentiometers
- USB interface to the MC main computer
- Trackball
- USB port with cover cap on front

Specifications:

- Supply voltage: DC 24 V/≈ 4 W
- 36 exchangeable snap-on keys with status LED, freely definable via PLC (assignment in accordance with PLC basic program: 12 axis keys, spindle start, spindle stop, 22 further function keys)
- Further operating elements: NC start¹⁾, NC stop¹⁾, emergency-stop key, control voltage on¹⁾, holes for additional keys or keylock switches
- Connection for HR handwheel
- HSCI interface
- TE 360: 8 free PLC inputs and 8 free PLC outputs
TE 360 FS: 4 free FS inputs and 8 free PLC outputs; additional dual-channel FS inputs for emergency stop and permissive buttons of the handwheel.

¹⁾ Illuminated keys, addressable via PLC

Standard potentiometer layout:

TE 360 ID 1280184-xx
TE 360 FS ID 1275710-xx
Mass ≈ 5.8 kg

Alternative potentiometer layout:

TE 360 ID 1284265-xx
TE 360 FS ID 1284263-xx
Mass ≈ 5.8 kg



TE 360 with standard potentiometer layout



TE 360 with alternative potentiometer layout

PL 6000 PLC input/output systems with HSCI

PL 6000

The PLC inputs and outputs are available via external modular PL 6000 PLC input/output systems. They consist of a basic module and one or more input/output modules. A total maximum of 1000 inputs/outputs is supported. The PL 6000 units are connected to the MC main computer via the HSCI interface. The PL 6000 units are configured with the IOconfig PC software.



PLB 62xx

Basic modules

Basic modules with an **HSCI interface** exist for 4, 6, 8, and 10 modules. Fastening is performed on standard NS 35 rails (DIN 46227 or EN 50022).

Supply voltage	DC 24 V
Power consumption ¹⁾	≈ 48 W at DC 24 V NC ≈ 21 W at DC 24 V PLC
Mass	≈ 0.36 kg (bare)

¹⁾ PLB 6xxx completely filled, incl. TS, TT. For more details with regard to sizing the power supply for DC 24 V NC, see *Power supply for HSCI components*.

System PL with EnDat support

- Required once for each control system (except with UEC)
- Connections for TS and TT touch probes
- TS and TT touch probes with EnDat interface are supported
- Safety-relevant inputs/outputs
- *Without FS*: 12 free inputs, 7 free outputs
With FS: 6 free FS inputs, 2 free FS outputs
- The slots are fitted with cover strips, so no empty housings are needed
- Software support as of NC software 34059x-08
- Enabling of functional safety with the PLB 62xx FS

PLB 6204	For 4 I/O modules	ID 1129809-xx
PLB 6206	For 6 I/O modules	ID 1129812-xx
PLB 6208	For 8 I/O modules	ID 1129813-xx
PLB 6210	For 10 I/O modules	ID 1278136-xx

PLB 6204 FS	For 4 I/O modules	ID 1129808-xx
PLB 6206 FS	For 6 I/O modules	ID 1129811-xx
PLB 6208 FS	For 8 I/O modules	ID 1129810-xx
PLB 6210 FS	For 10 I/O modules	ID 1278134-xx

Gen³ ready

Expansion PL

Gen3 ready

For connection to the system PL to increase the number of PLC inputs/outputs

PLB 6104	For 4 I/O modules	ID 1129799-xx
PLB 6106	For 6 I/O modules	ID 1129803-xx
PLB 6108	For 8 I/O modules	ID 1129804-xx
PLB 6104 FS	For 4 I/O modules	ID 1129796-xx
PLB 6106 FS	For 6 I/O modules	ID 1129806-xx
PLB 6108 FS	For 8 I/O modules	ID 1129807-xx

Up to seven PLB 6xxx can be connected to the control.

I/O modules

Gen3 ready

There are I/O modules with digital and analog inputs and outputs. For partially occupied basic modules, the unused slots must be occupied by an empty housing.

PLD-H 16-08-00	I/O module with 16 digital inputs and 8 digital outputs	ID 594243-xx
PLD-H 08-16-00	I/O module with 8 digital inputs and 16 digital outputs	ID 650891-xx
PLD-H 08-04-00 FS	I/O module with 8 digital FS inputs and 4 digital FS outputs	ID 598905-xx
PLD-H 04-08-00 FS	I/O module with 4 digital FS inputs and 8 digital FS outputs	ID 727219-xx
PLD-H 04-04-00 HSLs FS	I/O module with 4 digital FS inputs and 4 high-side/low-side FS outputs	ID 746706-xx

Total current	Outputs 0 to 7: ≤ 2 A per output (≤ 8 A simultaneously)
Power output	Max. 200 W
Mass	≈ 0.2 kg

PLA-H 08-04-04	Analog module for PL 6xxx with <ul style="list-style-type: none">• 8 analog inputs, ± 10 V• 4 analog outputs, ± 10 V• 4 analog inputs for PT 100 thermistors	ID 675572-xx
Mass	≈ 0.2 kg	

IOconfig (accessory)

PC software for configuring HSCI and PROFIBUS components

Accessories

Power supply for HSCI components

PSL 13x

HEIDENHAIN offers the PSL 13x power supply unit in order to power the HSCI components. Either line voltage and DC-link voltage or only line voltage is provided to the PSL 13x. The PSL 13x provides the safely separated DC 24 V PELV NC power supply required for the HSCI components by EN 61800-5-1. The NC supply voltage and the PLC supply voltage are separated from each other by basic insulation.

Supply voltage	<ul style="list-style-type: none"> • PSL 13x (L1, L2): AC 400 V (360 V to 480 V), 50/60 Hz • PSL 13x (DC-link voltage): DC 400 V to 750 V • Power consumption ≤ 1000 W
Outputs	<p>NC: DC 24 V ≤ 20 A (double insulation from line power) DC 5 V ≤ 16 A (only for PSL 135) galvanically connected with DC 24 V NC</p> <p>PLC: DC 24 V ≤ 20 A (basic insulation from line power)</p> <p>Total: ≤ 32 A/750 W</p>



PSL 130

The **PSL 130** serves as a DC 24 V power supply unit for supplying the HSCI components. It is not necessary in connection with the UEC if the total current consumption of the connected HSCI components does not exceed 3.5 A.

HSCI components		Current consumption DC 24 V NC
Main computer	MC 6541, MC 6542 MC 6641, MC 7532 MC 7522	2.0 A 3.2 A 2.5 A
Machine operating panel	PLB 600x MB 7x0	0.2 A (without handwheel) 0.2 A (without handwheel)
Keyboard	TE 7x5 (MB integrated)	0.2 A (without handwheel)
PLC inputs/outputs	PLB 62xx PLB 61xx PLD PLA	0.3 A (without touch probe) 0.2 A 0.05 A 0.1 A
Monitor	BF 750 BF 860	2.1 A 1.9 A
Handwheels	HR 520 HRA 551 FS + HR 550 FS HR 510 HR 130	0.05 A 0.5 A (during charging) 0.05 A 0.05 A
Touch probes	See specifications of the touch probes	

The **PSL 135** has an additional DC 5 V output and is therefore suited for supplying the CC controller unit and the MC main computer. It might be necessary with multi-row configuration.

	Module width	Degree of protection	Mass	
PSL 130	50 mm	IP20	≈ 2.1 kg	ID 575047-xx
PSL 135	50 mm	IP20	≈ 2.5 kg	ID 627032-xx

The UV(R) supply units currently available also feature an integrated power supply that provides DC 24 V to HSCI components.

HSCI adapter for OEM machine operating panel

PLB 600x

Gen3 ready

The PLB 600x HSCI adapter is required in order to connect an OEM-specific machine operating panel to the TNC 640. The spindle-speed and feed-rate override potentiometers of the TE 7xx and the HR handwheel are also connected to these adapters.

- HSCI interface
- Connection for HR handwheel
- Inputs/outputs for keys/key illumination
 - PLB 6001*: terminals for 72 PLC inputs and 40 PLC outputs
 - PLB 6001 FS*: terminals for 36 FS inputs and 40 PLC outputs
 - PLB 6002 FS*: terminals for 4 FS inputs, 64 PLC inputs and 40 PLC outputs
- Screw fastening or top-hat-rail mounting
- Configuration of the PLC inputs/outputs with the IOconfig computer software

PLB 6001 ID 668792-xx

PLB 6001 FS ID 722083-xx

PLB 6002 FS ID 1137000-xx

Mass ≈ 1.2 kg

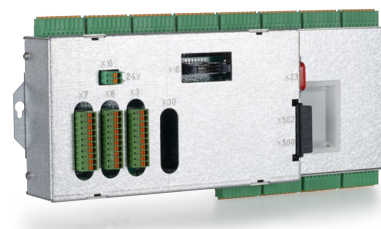

PLB 6001

Additional modules

Overview

The additional modules are directly connected to the HSCI control system through a slot on the MC main computer, on the CC controller unit, or on the UEC or UMC inverter.

Module for analog axes

Digital drive designs sometimes also require analog axes or spindles. The additional module CMA-H 04-04-00 (Controller Module Analog—HSCI) makes it possible to integrate analog drive systems in an HSCI system.

The CMA-H is integrated into the HSCI control system via a slot on the underside of the CC or UEC. Every controller unit has slots for two boards. The CMA-H does not increase the total number of available axes: every analog axis used reduces the number of available digital control loops by one. Analog control loops also need to be enabled on the SIK. The analog control-loop outputs can be accessed only via the NC, not via the PLC.

Additional module for analog axes/spindles:

- Expansion board for CC 61xx or UEC controller units
- 4 analog outputs, ± 10 V for axes/spindle
- Spring-type plug-in terminals

CMA-H 04-04-00

ID 688721-xx

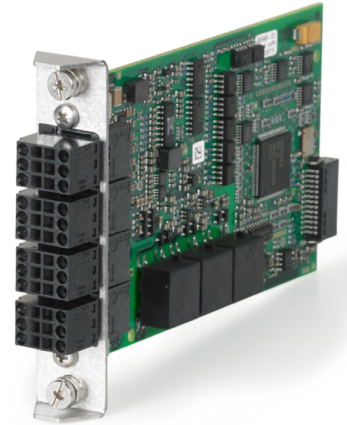

CMA-H 04-04-00

Fieldbus systems

An expansion board can be used to provide the TNC 640 with a PROFIBUS or PROFINET interface at any time. The modules are integrated into the control system through a slot on the MC. This makes the connection to an appropriate fieldbus system as a master possible. As of version 3.0, the interface is configured with IOconfig.

PROFIBUS DP module

Additional module for PROFIBUS DP:

- Expansion board for the MC main computer
- Connection for 9-pin D-sub connector (female) to X121

PROFIBUS DP additional module

ID 828539-xx



PROFIBUS DP module

PROFINET IO module

Additional module for PROFINET IO:

- Expansion board for the MC main computer
- RJ45 connection at X621 and X622

PROFINET IO additional module

ID 828541-xx



PROFINET IO module

Combined PROFIBUS DP/PROFINET IO module

Additional module for PROFIBUS DP and PROFINET IO:

- Expansion board for the MC main computer
- Connection for RJ45 connector to X621 (PROFINET IO) and M12 connector to X121 (PROFIBUS DP)
- Additionally connectable terminating resistor for PROFIBUS DP with front LED

Additional PROFIBUS DP and PROFINET IO

ID 1160940-xx



Combined module

Touch probes

Overview

Touch probes for tool and workpiece measurement are connected via the system PL 62xx or the UEC/UMC. These touch probes generate a trigger signal that saves the current position value to the NC. The EnDat interface makes touch probes intelligent and allows for greater convenience when connecting them to HEIDENHAIN controls. For more information on touch probes, please refer to the *Touch Probes for Machine Tools* brochure (ID 1113984).

Workpiece measurement

The TS touch trigger probes feature a stylus for probing workpieces. HEIDENHAIN controls feature standard routines for aligning and measuring workpieces, and for setting presets. The touch probes are available with various clamping shanks. Assorted styli are available as accessories.

Touch probes with **cable-bound signal transmission**:

TS 260 Touch probe for milling, turning, drilling, boring, and grinding machines with manual tool changing capability

TS 248 Like the TS 260, but with reduced deflection forces



TS 260

Touch probes with **cableless signal transmission** for machining centers and milling, drilling, and boring machines with automated tool changing capability (for the appropriate transceiver, see Page 37):

TS 460 Touch probe with **radio and infrared transmission**:

- Hybrid technology: signal transmission via radio and infrared signals
- Large transmission range and long operating time
- Mechanical collision protection and thermal decoupling
- With EnDat functionality



TS 460

Touch probes with **infrared transmission**:

TS 642 Activation via switch in taper shank

TS 740 High probing accuracy and reproducibility, low probing force

Tool measurement

The touch probes for tool measurement from HEIDENHAIN are suited for probing stationary or rotating tools directly on the machine. The TNC 640 features standard cycles for the measurement of tool length and diameter, as well as of individual teeth. The TNC 640 automatically saves the measured tool dimensions in a tool table. It is also possible to measure tool wear between two machining steps. For the next machining operation, the TNC 640 automatically compensates for the tool dimensions or inserts a replacement tool (as when a tool breaks).

With the **TT touch trigger probes**, the disk-shaped probe contact is deflected from its resting position by contact with the stationary or rotating tool, and a trigger signal is transmitted to the TNC 640.

TT 160

Touch probe with signal transmission to the control via a connected cable



TT 160

TT 460

Touch probe with hybrid technology: radio or infrared-beam transmission (for the appropriate transceiver, see below). Optionally available with EnDat functionality.

Transceiver

Radio and infrared communication is established between the TS or TT touch probe and the SE transceiver.

SE 660 for radio and infrared transmission (hybrid technology); SE unit for both the TS 460 and TT 460;

SE 661 for radio and infrared transmission (hybrid technology); SE for both the TS 460 and TT 460; EnDat functionality for the transmission of the switching status, as well as for diagnostic information and additional data.

SE 540 for infrared transmission; for installation in the spindle head

SE 642 for infrared transmission; SE for both the TS and TT



SE 661

The following combinations are possible:

	SE 660	SE 661*	SE 540	SE 642
TS 460	Radio/infrared		Infrared	Infrared
TS 642	Infrared	–	Infrared	Infrared
TS 740	–		Infrared	Infrared
TT 460	Radio/infrared		Infrared	Infrared

* With EnDat interface

UTI 660

The UTI 660 interface unit is required for connecting multiple TS 460 and TT 460 touch probes to a HEIDENHAIN control that does not support EnDat. With the UTI 660, up to four touch probes (TS 460 / TT 460 / combined) can be operated with an SE 660 on the control.

ID 1169537-01



Electronic handwheels

Overview

Support for electronic handwheels is standard on the TNC 640:

- **HR 550 FS** wireless handwheel, or
- **HR 510** or **HR 520** portable handwheel, or
- **HR 130** panel-mounted handwheel

It is possible to operate up to five handwheels or handwheel adapters on a single TNC 640:

- One handwheel via the handwheel input of the main computer
- One handwheel each on up to four HSCI machine operating panels or the PLB 600x HSCI adapter

A mixed operation of handwheels with and without display is not possible. Handwheels with functional safety are cross-circuit-proof due to their special permissive-button logic.

HR 510

Portable electronic handwheel with:

- Keys for actual-position capture and the selection of five axes
- Keys for traverse direction and three preset feed rates
- Three keys for machine functions (see below)
- Emergency stop button and two permissive buttons (24 V)
- Magnetic holding pads

All keys are designed as snap-on keys and can be replaced by keys with other symbols (see overview for HR 510 in *Snap-on keys for handwheels*).

	Keys	Without detent	With detent
HR 510	NC start/stop, spindle start (for basic PLC program)	ID 1119971-xx	ID 1120313-xx
	FCT A, FCT B, FCT C	ID 1099897-xx	–
	Spindle right/left/stop	ID 1184691-xx	–
HR 510 FS	NC start/stop, spindle start (for basic PLC program)	ID 1120311-xx	ID 1161281-xx
	FCT A, FCT B, FCT C	–	ID 1120314-xx
	Spindle start, FCT B, NC start	–	ID 1119974-xx

Mass ≈ 0.6 kg



HR 510

HR 520

- Portable electronic handwheel with:
- Display for operating mode, actual position value, programmed feed rate and spindle speed, error messages
 - Override potentiometers for feed rate and spindle speed
 - Selection of axes via keys or soft keys
 - Actual position capture
 - NC start/stop
 - Spindle on/off
 - Keys for continuous traverse of the axes
 - Soft keys for machine functions of the machine manufacturer
 - Emergency stop button

	Without detent	With detent
HR 520	ID 670302-xx	ID 670303-xx
HR 520 FS	ID 670304-xx	ID 670305-xx

Mass ≈ 1 kg



HR 520

Holder for HR 520

For attaching to a machine ID 591065-xx

HR 550 FS

Electronic handwheel with wireless transmission. Display, operating elements, and functions are like those of the HR 520

In addition:

- Functional safety (FS)
- Radio transmission range of up to 20 m (depending on environment)

HR 550 FS	Without detent	ID 1200495-xx
	With detent	ID 1183021-xx

Replacement battery For HR 550 FS ID 623166-xx



HR 550 FS with HRA 551 FS

HRA 551 FS

- Handwheel holder for HR 550 FS
- For docking the HR 550 FS onto the machine
 - Integrated battery charger for HR 550 FS
 - Connections to the control and the machine
 - Integrated transceiver
 - HR 550 FS magnetically held to front of HRA 551 FS

HRA 551 FS ID 1119052-xx
Mass ≈ 1.0 kg

For more information, see the *HR 550 FS* Product Information document.

Connecting cables

	HR 510	HR 510 FS	HR 520	HR 520 FS	HR 550 FS with HRA 551 FS	
Connecting cable (spiral cable) to HR (3 m)	–	–	✓	✓	–	ID 312879-01
	✓	✓	–	–	–	ID1117852-03
Connecting cable with metal armor	–	–	✓	✓	–	ID 296687-xx
	✓	✓	–	–	–	ID 1117855-xx
Connecting cable without metal armor	–	–	✓	✓	✓ (max. 2 m)	ID 296467-xx
	✓	✓	–	–	–	ID 1117853-xx
Adapter cable for HR/HRA to MC, straight connector	✓	✓	✓	✓	✓ ¹⁾	ID 1161072-xx
Adapter cable for HR/HRA to MC, angled connector (1 m)	✓	✓	✓	✓	✓ ¹⁾	ID 1218563-01
Extension cable to adapter cable	✓	✓	✓	✓	✓ ¹⁾	ID 281429-xx
Adapter cable for HRA to MC	–	–	–	–	✓ ²⁾	ID 749368-xx
Extension cable to adapter cable	–	–	–	–	✓ ²⁾	ID 749369-xx
Adapter connector for handwheels without functional safety	✓	–	✓	–	–	ID 271958-03
Adapter connector for handwheels with functional safety	–	✓	–	✓	✓	ID 271958-05

¹⁾ For maximum cable lengths up to 20 m between the MB and HRA 551 FS

²⁾ For maximum cable lengths up to 50 m between the MB and HRA 551 FS

See also *Cable overview* on Page 51.

HR 130

Panel-mounted handwheel with ergonomic control knob.
It is attached to the MB 7x0 or the TE 7x5 either directly or via an
extension cable.

HR 130	Without detent	ID 540940-03
	With detent	ID 540940-01
Mass	≈ 0.7 kg	



HR 130

Industrial PC

Additional operating station

The additional ITC operating stations (Industrial Thin Clients) from HEIDENHAIN are convenient solutions for the additional, decentralized operation of the machine or of machine units such as tool-changing stations. The remote operation strategy, which is tailored to the TNC 640, makes it very easy to connect the ITC over a standard Ethernet connection with a cable length of up to 100 m.

Connecting an ITC is very easy: as soon as the TNC 640 identifies an ITC, it provides it with a current operating system. After the ITC has been started, the complete content of the main screen is mirrored to the ITC's screen. As a result of this plug-and-play principle, no configuration by the machine tool builder is necessary. With the standard configuration of the Ethernet interface at X116, the TNC 640 integrates the ITC into the system fully self-sufficiently.



ITC 755

With touchscreen

The **ITC 755** is a compact additional operating station for control systems with a 15-inch or 19-inch main screen. Along with the ASCII keyboard and touchscreen it also has the most important function keys of the TNC 640. The ITC 755 adjusts its resolution automatically to fit the size of the main screen. The soft keys are pressed on the touchscreen.

The **ITC 860** (19-inch screen) and the keyboard unit (to be ordered separately) together comprise a complete second operating station. Along with the touchscreen, it also has the most important function keys of the control. The soft keys are pressed on the touchscreen.

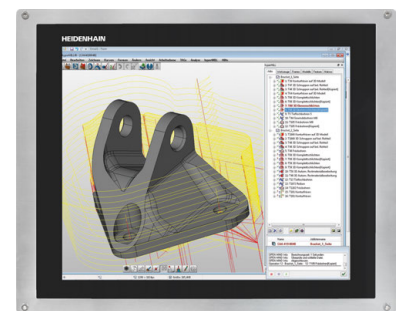

ITC 860

ITC 755¹⁾ ID 1039527-xx
ITC 860¹⁾ ID 1174935-xx

With operating keys

The **ITC 750** (15-inch screen) and the keyboard unit (to be ordered separately) form a complete second operating station.

ITC 750¹⁾ With 15-inch screen ID 1039544-xx
 for TE 73x

¹⁾ No NRTL approval

**IPC 6641
for Windows**

With the IPC 6641 industrial PC, you can start and remotely operate Windows-based applications via the user interface of the TNC 640. The user interface is displayed on the control screen. Software option 133 is required for this.

Since Windows runs on the industrial PC, Windows has no effect on the NC machining process. The IPC is connected to the NC main computer via Ethernet. No second screen is necessary, since the Windows applications are displayed on the TNC 640's screen via remote accesses.

Along with the IPC 6641 industrial PC, a hard disk (to be ordered separately) is required for operation. The Windows 8 or 10 operating system can be installed on the empty data carrier.

IPC 6641	With 8 GB of RAM	ID 1039543-01
	With 16 GB of RAM	ID 1039543-02
	Installation type	Electrical cabinet
	Processor	Intel Core i7-3 2.1 GHz, quad-core
	Mass	≈ 4.0 kg

HDR hard disk		ID 1074770-51
	Empty data carrier for Windows OS	
	Free capacity	≈ 160 GB



IPC 6641

Control of auxiliary axes

Gen3 ready

PNC 610

The PNC 610 auxiliary axis control is designed for controlling PLC axes independently of the TNC 640. The PNC 610 does not have an NC channel and thus cannot perform interpolating NC movements. With the IPC auxiliary computer, SIK, and CFR storage medium, the PNC 610 is a separate HSCI system, which can be expanded with HEIDENHAIN inverters. The standard PNC 610 features activation for six PLC axes.

The system's design is identical to that of the TNC 640. All relevant HEIDENHAIN tools and a basic program can be used. The position information can be transmitted over PROFIBUS DP (optional), PROFINET IO (optional), or TCP/IP (integrated, system is not capable of real-time), regardless of the platform.

Auxiliary computer

The IPC auxiliary computer features the following:

- Processor
- RAM memory
- HSCI interface to the CC controller unit or to the UEC and to other control components
- USB 3.0 interface

The following components must be ordered separately by the OEM and installed in the auxiliary computer:

- CFR CompactFlash memory card with the NC software
- System Identification Key component (SIK) for enabling software options

The following HSCI components are required for operation of the TNC 640:

- IPC auxiliary computer
- Controller unit
- PLB 62xx PLC input/output unit (system PL; integrated in UEC/UMC)

Interfaces

For the end user, USB 3.0, V.24/RS-232-C, and Ethernet interfaces are available on the MC. The connection to PROFINET IO or PROFIBUS DP is possible via an additional module.

Power supply

The DC 24 V power supply of the auxiliary computer and other HSCI components is provided through the PSL 13x supply unit with a supply voltage of 24 V-NC, or through the power supply of a UEC compact inverter. For the entire HSCI system, this DC 24 V-NC supply voltage is required to be safely separated voltage (PELV). It must not be connected to the DC 24 V supply voltage for PLC components (e.g., holding brakes).

Design

IPC 6490	ID number	ID 1039541-xx
	Mounting location	Electrical cabinet
	Mass	≈ 2.3 kg
	Power consumption	48 W
	RAM	2 GB
	Processor	Intel Celeron Dual Core, 1.4 GHz
IPC 8420	ID number	ID 1249510-xx
	Mounting location	Operating panel
	Mass	≈ 6.7 kg
	Power consumption	48 W
	Screen	15.6-inch, with touchscreen operation
	RAM	2 GB
	Processor	Intel Celeron Dual Core, 1.4 GHz

Export version

Because the complete NC software is saved on the CFR CompactFlash storage medium, no export version is required for the main computer itself. The NC software of the PNC 610 needs no export license.

Software options

The performance of the PNC 610 can also be adapted to the actual requirements at a later time through software options. Software options are enabled and saved in the SIK component through the entry of keywords based on the SIK number. Please provide the SIK number when ordering new options.

Option number	Option	ID	Remark	Page
18	HEIDENHAIN DNC	526451-01	Communication with external PC applications over COM component	94
24	Gantry Axes	634621-01	Gantry axes in master-slave torque control	
46	Python OEM Process	579650-01	Execute Python applications	89
135	Synchronizing Functions	1085731-01	Expanded synchronization of axes and spindles	65
141	Cross Talk Comp.	800542-01	CTC: compensation of axis couplings	77
142	Pos. Adapt. Control	800544-01	PAC: position-dependent adaptation of control parameters	77
143	Load Adapt. Control	800545-01	LAC: load-dependent adaptation of control parameters	76
144	Motion Adaptive Control	800546-01	MAC: motion-dependent adaptation of control parameters	76

Storage medium The storage medium is a CFR (= CompactFlash Removable) compact flash memory card. It carries the NC software 817591-08. The storage medium is removable and must be ordered separately from the main computer. The NC software is based on the HEIDENHAIN HEROS 5 operating system.

CFR CompactFlash, 30 GB ID 1102057-58
No export license required
Free capacity for PLC programs 4 GB

SIK component The SIK component holds the NC software license for enabling software options. It gives the main computer an unambiguous ID code—the SIK number. The SIK component is ordered and shipped separately. It must be inserted into a special slot in the IPC auxiliary computer. The SIK component of the PNC can enable six axes. The enabling of up to the maximum number of ten axes must be performed via the UMC compact inverter.

SIK component for PNC 610 ID 617763-53

TNCkeygen (accessory) TNCkeygen is a collection of PC software tools for generating enabling keys for HEIDENHAIN controls for a limited period of time see "TNCkeygen (accessory)", Page 19.

Camera system

Gen3 ready

VS 101

The VS 101 camera system, in conjunction with Visual Setup Control (software option 136), enables you to monitor the working space of the machine. The sealed and extremely sturdy VS 101 camera system is designed for integration into the machine's working space. The protective housing features a closing cover and connections for sealing air to prevent the camera optics from being damaged. The VS 101 camera system can be connected directly to the control's main computer over a Gbit Ethernet interface.

The camera system can be adapted using various lenses to the respective machine size. The proper lens selection depends on various factors. For more information, please contact HEIDENHAIN.

VS 101

Mass \approx 2.3 kg

ID 1137063-xx









































































































VS 101

Snap-on keys for handwheels

Snap-on keys











The snap-on keys make it easy to replace the key symbols. In this way, the HR handwheel can be adapted to different requirements. The snap-on keys are available in packs of five keys.

Overview for HR 520, HR 520 FS, and HR 550 FS











Axis keys Orange		ID 330816-42		ID 330816-24		ID 330816-43		ID 330816-37
		ID 330816-26		ID 330816-36		ID 330816-38		
		ID 330816-23		ID 330816-25		ID 330816-45		
Gray		ID 330816-95		ID 330816-69		ID 330816-0W		ID 330816-0R
		ID 330816-96		ID 330816-0G		ID 330816-0V		ID 330816-0D
		ID 330816-97		ID 330816-0H		ID 330816-0N		ID 330816-0E
		ID 330816-98		ID 330816-71		ID 330816-0M		ID 330816-65
		ID 330816-99		ID 330816-72		ID 330816-67		ID 330816-66
		ID 330816-0A		ID 330816-63		ID 330816-68		ID 330816-19
		ID 330816-0B		ID 330816-64		ID 330816-21		ID 330816-16
		ID 330816-0C		ID 330816-18		ID 330816-20		ID 330816-0L
		ID 330816-70		ID 330816-17		ID 330816-0P		ID 330816-0K
	Machine functions		ID 330816-0X		ID 330816-75		ID 330816-0T	
		Black ID 330816-1Y		ID 330816-76		ID 330816-81		ID 330816-87
		Black ID 330816-30		ID 330816-77		ID 330816-82		ID 330816-88
		Black ID 330816-31		ID 330816-78		ID 330816-83		ID 330816-94
		Black ID 330816-32		ID 330816-79		ID 330816-84		ID 330816-0U
		ID 330816-73		ID 330816-80		ID 330816-89		ID 330816-91
		ID 330816-74		ID 330816-0S		ID 330816-85		ID 330816-3L
Spindle functions			Red ID 330816-08		ID 330816-40		Red ID 330816-47	
		Green ID 330816-09		ID 330816-41		Green ID 330816-46		ID 385530-5X
Other keys		Black ID 330816-01		Red ID 330816-50		ID 330816-90		ID 330816-93
		Gray ID 330816-61		ID 330816-33		Black ID 330816-27		0 ID 330816-0Y
		Green ID 330816-11		ID 330816-34		Black ID 330816-28		Black ID 330816-4M
		Red ID 330816-12		ID 330816-13		Black ID 330816-29		ID 330816-3M
		Green ID 330816-49		Green ID 330816-22		ID 330816-92		ID 330816-3N

Overview for HR 510 and HR 510 FS







Axis keys
Orange

	ID 1092562-02		ID 1092562-05		ID 1092562-36		ID 1092562-08
	ID 1092562-03		ID 1092562-06		ID 1092562-09		
	ID 1092562-04		ID 1092562-07		ID 1092562-37		







Gray

	ID 1092562-28		ID 1092562-31		ID 1092562-24		ID 1092562-27
	ID 1092562-29		ID 1092562-32		ID 1092562-25		
	ID 1092562-30		ID 1092562-33		ID 1092562-26		













Machine functions

	Black ID 1092562-14		Black ID 1092562-15		Black ID 1092562-16		ID 1092562-42
	ID 1092562-43		ID 1092562-44				

Spindle functions

	ID 1092562-18		ID 1092562-19		Green ID 1092562-22		Red ID 1092562-17
	Red ID 1092562-38		ID 1092562-41				

Other keys

	Black ID 1092562-01		Green ID 1092562-23		ID 1092562-13		ID 1092562-35
	Green ID 1092562-20		ID 1092562-11		Black ID 1092562-10		Gray ID 1092562-39
	Red ID 1092562-21		ID 1092562-12		ID 1092562-34		Orange ID 1092562-40











Snap-on keys for the control

Snap-on keys







































The snap-on keys make it easy to replace the key symbols, thus allowing the keyboard to be adapted to different requirements. The snap-on keys are available in packs of five keys.

Overview of control keys









































Keys Orange

	ID 679843-31		ID 679843-54		ID 679843-C8		ID 679843-D4
	ID 679843-32		ID 679843-55		ID 679843-C9		
	ID 679843-53		ID 679843-88		ID 679843-D3		



















Gray

	ID 679843-03		ID 679843-13		ID 679843-93		ID 679843-B9
	ID 679843-04		ID 679843-14		ID 679843-94		ID 679843-C1
	ID 679843-05		ID 679843-43		ID 679843-B1		ID 679843-C2
	ID 679843-06		ID 679843-44		ID 679843-B2		ID 679843-C3
	ID 679843-07		ID 679843-67		ID 679843-B3		ID 679843-C4
	ID 679843-08		ID 679843-68		ID 679843-B4		ID 679843-C5
	ID 679843-09		ID 679843-69		ID 679843-B5		ID 679843-D9
	ID 679843-10		ID 679843-70		ID 679843-B6		ID 679843-E1
	ID 679843-11		ID 679843-91		ID 679843-B7		
	ID 679843-12		ID 679843-92		ID 679843-B8		































Machine functions

	ID 679843-01		ID 679843-30		ID 679843-74		ID 679843-C6
	ID 679843-02		ID 679843-40		ID 679843-76		Black ID 679843-C7
	ID 679843-16		Green ID 679843-56		Black ID 679843-95		ID 679843-D6
	ID 679843-22		Red ID 679843-57		Black ID 679843-96		ID 679843-E3
	ID 679843-23		ID 679843-59		Black ID 679843-A1		ID 679843-E4
	ID 679843-24		ID 679843-60		ID 679843-A2		ID 679843-E6
	ID 679843-25		ID 679843-61		ID 679843-A3		ID 679843-E7
	ID 679843-26		ID 679843-62		ID 679843-A4		ID 679843-E8
	ID 679843-27		ID 679843-63		ID 679843-A5		
	ID 679843-28		ID 679843-64		ID 679843-A6		
	ID 679843-29		ID 679843-73		ID 679843-A9		

Spindle functions

	ID 679843-18		ID 679843-47		Red ID 679843-52		ID 679843-99
	ID 679843-19		ID 679843-48		ID 679843-65		Green ID 679843-D8
	ID 679843-20		ID 679843-49		Green ID 679843-71		ID 679843-F2
	ID 679843-21		ID 679843-50		ID 679843-72		
	ID 679843-46		ID 679843-51		Red ID 679843-89		

Other keys

	ID 679843-15		ID 679843-39		ID 679843-97		Black ID 679843-E2
	ID 679843-17		ID 679843-41		ID 679843-98		ID 679843-E5
	Gray ID 679843-33		ID 679843-42		ID 679843-A7		ID 679843-F3
	Black ID 679843-34		Red ID 679843-45		ID 679843-A8		ID 679843-F4
	Orange ID 679843-35		ID 679843-58		Black ID 679843-D1		ID 679843-F5
	ID 679843-36		ID 679843-66		Black ID 679843-D2		ID 679843-F6
	ID 679843-37		ID 679843-75		ID 679843-D5		
	ID 679843-38		Green ID 679843-90		Red ID 679843-D7		

Special keys

Snap-on keys can also be made with special key symbols for special applications. The laser labeling differs in appearance from the labeling of the standard keys. If you need keys for special applications, please consult your contact person at HEIDENHAIN.

Control systems with UEC

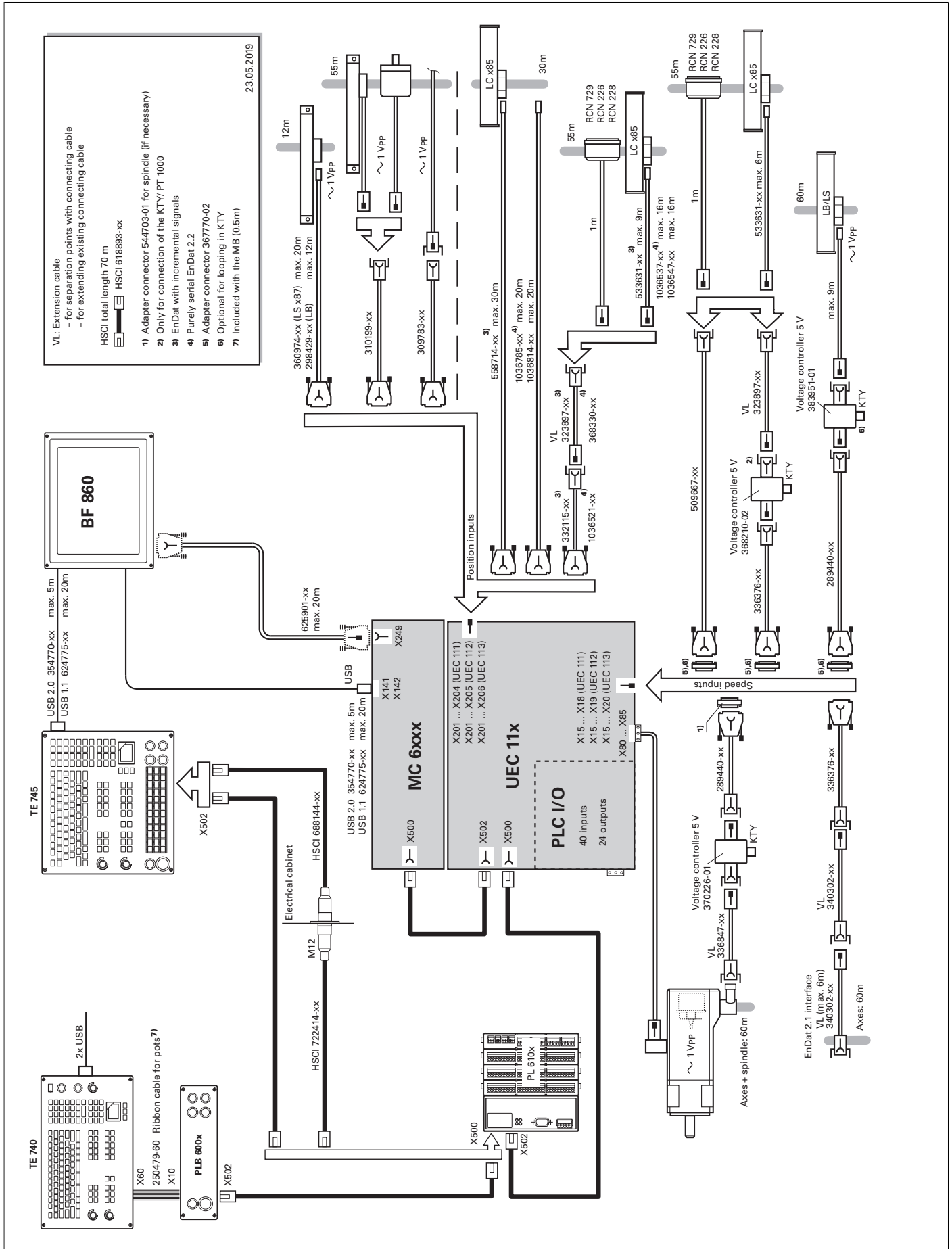

Inverter system

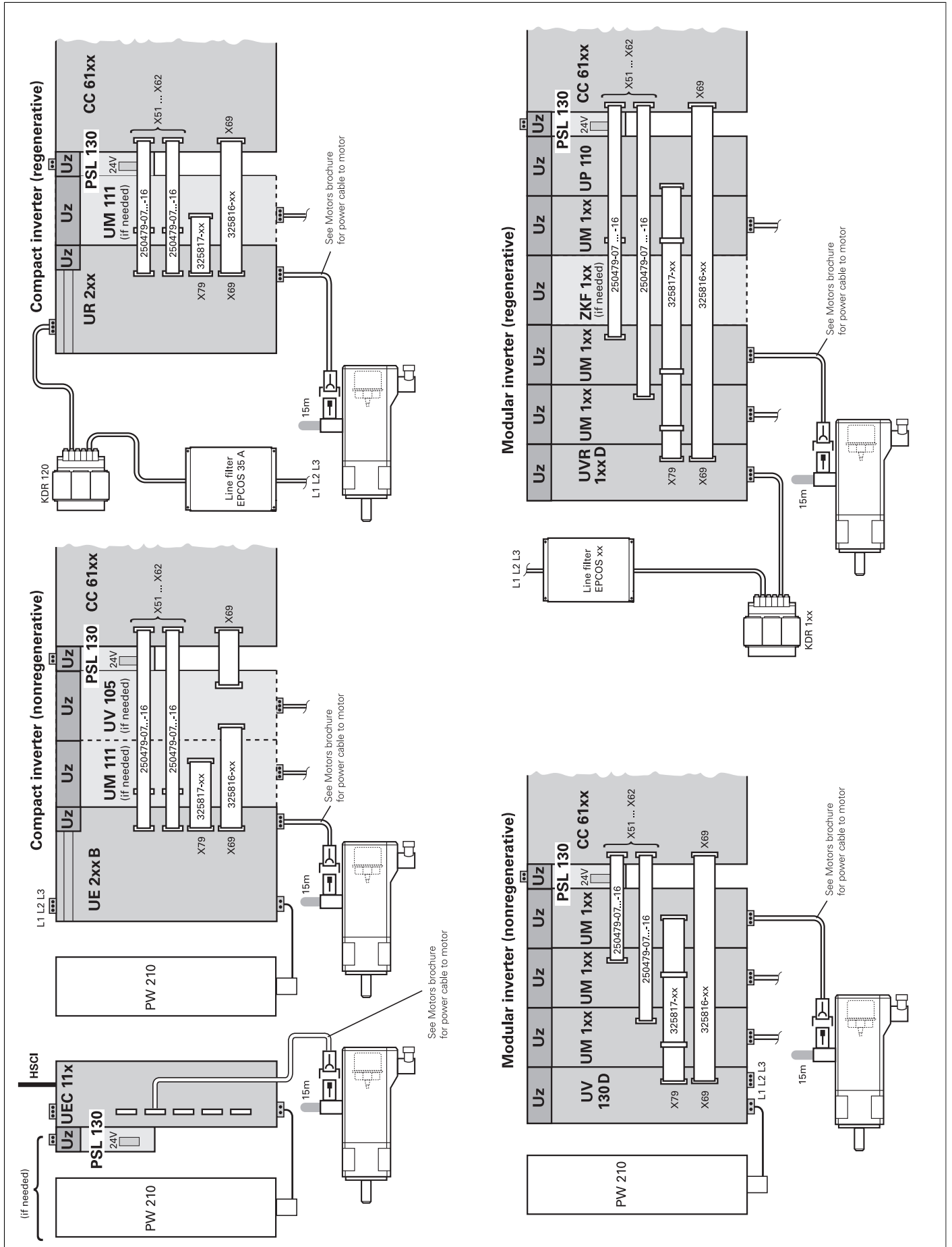

Encoders

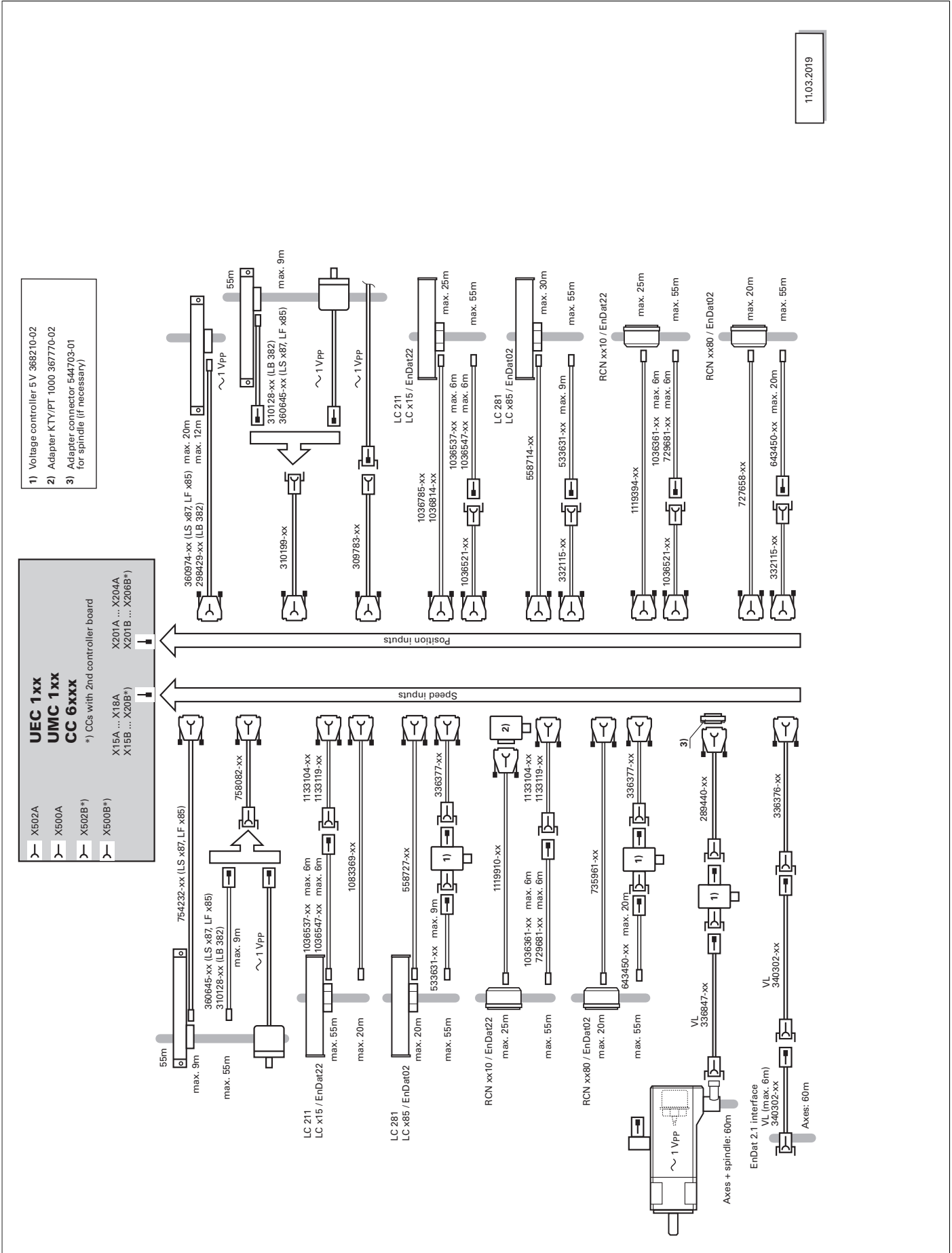

Accessories

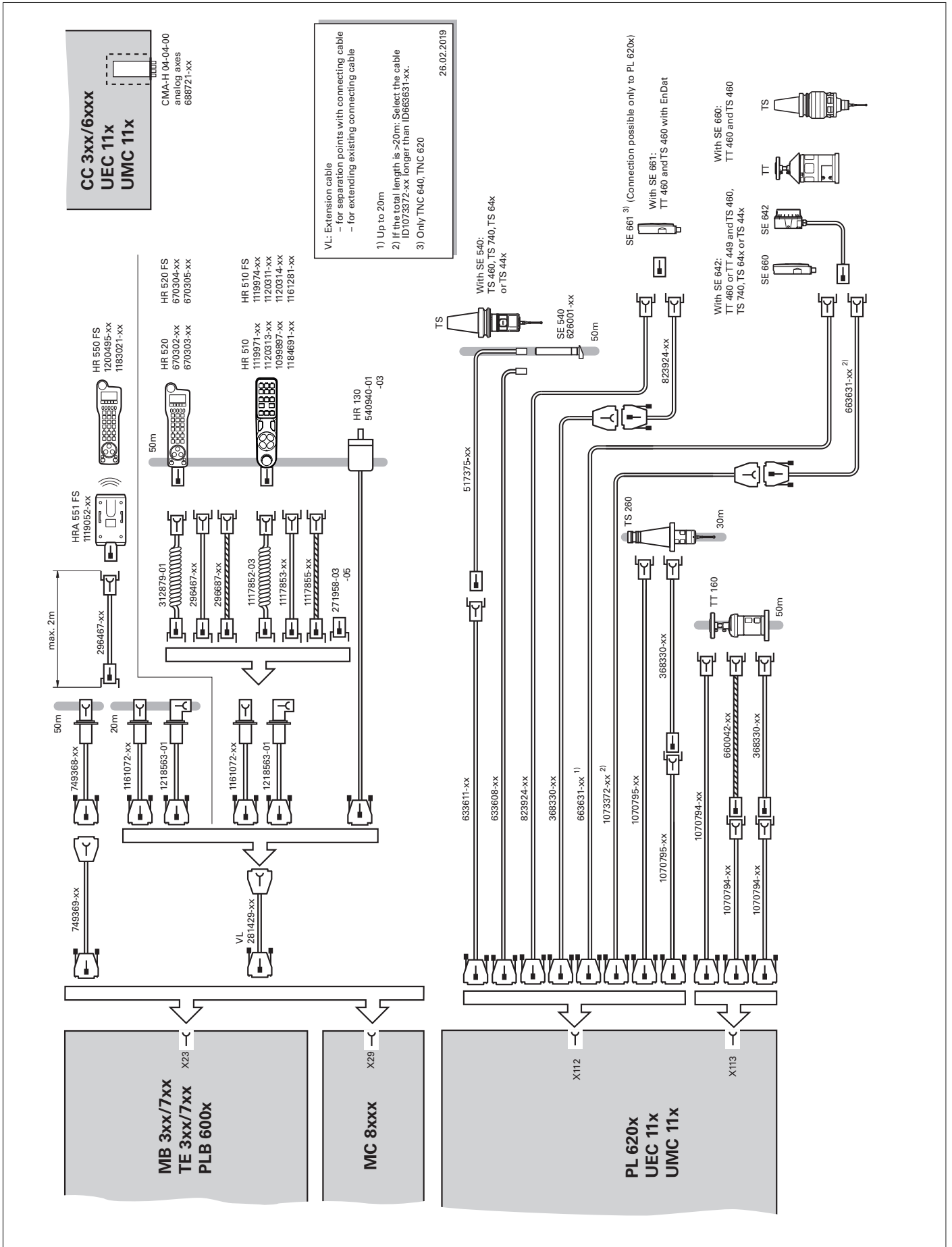

PNC 610 with UEC

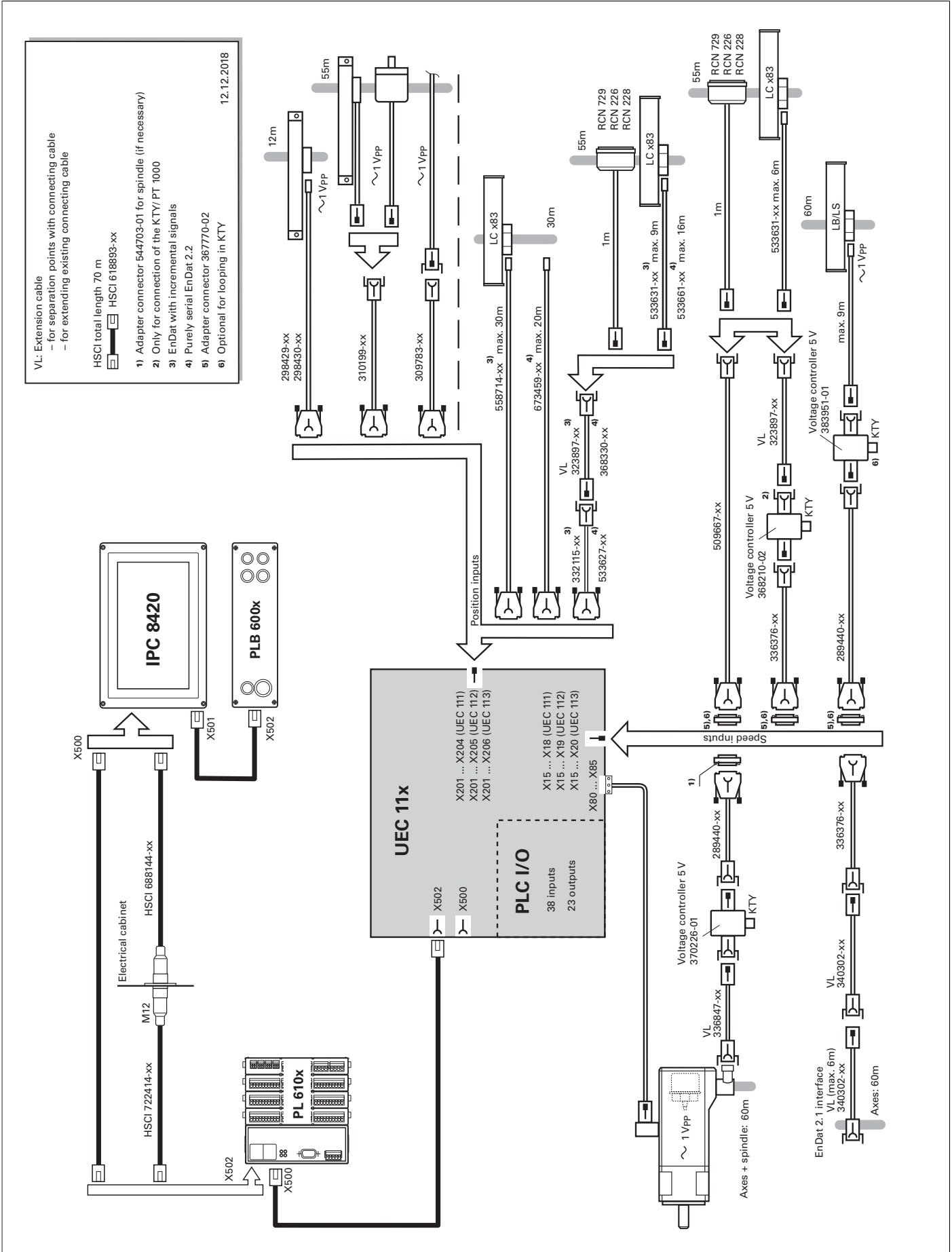

Technical description

Digital control design

Uniformly digital

In the uniformly digital control design from HEIDENHAIN, all of the components are connected to each other via purely digital interfaces. The control components are connected via the HEIDENHAIN Serial Controller Interface (**HSCI**), the HEIDENHAIN real-time protocol for fast Ethernet. The encoders are connected over **EnDat 2.2**, the bidirectional interface from HEIDENHAIN. A high degree of availability for the entire system, from the main computer to the encoder, is thereby achieved, with the system being diagnosable and immune to noise. The outstanding characteristics of the uniformly digital design from HEIDENHAIN guarantee very high accuracy and surface finish quality, combined with high traversing speeds. For more information, refer to the *Uniformly Digital* Technical Information document.

HSCI

HSCI, the HEIDENHAIN Serial Controller Interface, connects the main computer, controller(s), and other control components. The connection between two HSCI components is also referred to as an HSCI segment. HSCI is based on 100BaseT Ethernet hardware. A special interface component developed by HEIDENHAIN enables short cycle times for data transfer.

Main advantages of the control design with HSCI:

- Hardware platform for a flexible and scalable control system (e.g., decentralized axis systems)
- High noise immunity due to digital communication between components
- Hardware basis for implementing "functional safety"
- Simple wiring (commissioning, configuration)
- Inverter connection via proven PWM interface
- Large cable lengths in the entire system (HSCI segment up to max. 70 m)
- High number of possible control loops
- High number of PLC inputs/outputs
- Decentralized arrangement of the controller units

CC or UEC controller units, up to nine PL 6000 PLC I/O modules, and machine operating panels (e.g., MB 72x from HEIDENHAIN) can be connected to the serial HSCI bus of the MC main computer. The HR handwheel is connected directly to the machine operating panel. The combination of monitor and main computer is especially advantageous if the computer is housed in the operating panel. Besides the power supply, all that is then required is an HSCI line to the controller unit in the electrical cabinet.

Maximum cable lengths for HSCI:

- For one HSCI segment: 70 m
- For up to 11 HSCI slaves: 290 m (total of all HSCI segments)
- For up to 12 HSCI slaves (maximum configuration): 180 m (total of all HSCI segments)

The maximum permissible number of individual HSCI participants is listed below.

HSCI components		Maximum number	
MC/IPC	HSCI master	1 in the system	
CC, UEC, UMC	HSCI slave	4 controller motherboards (distributed to CC, UEC, UMC as desired)	
MB, PLB 600x	HSCI slave	2 in the system	
PLB 61xx, PLB 62xx	HSCI slave	6 in the system	
HR	On MB and/or PLB 600x	5 in the system	
PLD-H-xx-xx-xx FS	In PLB 6xxx FS	10 in the system	Total maximum of 1000 inputs/outputs
PLD-H-xx-xx-xx, PLA-H-xx-xx-xx	In PLB 6xxx	25 in the system	

Control systems with integrated functional safety (FS)

Basic principle	<p>With controls featuring integrated functional safety (FS) from HEIDENHAIN, it is possible to attain Safety Integrity Level 2 (SIL 2) in accordance with EN 61508, and Performance Level “d,” Category 3, as per EN ISO 13849-1 (successor standard to EN 954-1). In these standards, the assessment of safety-related systems is based on, among other things, the failure probabilities of integrated components and subsystems. This modular approach aids the manufacturers of safety-related machines in implementing their systems, since they can then build upon prequalified subsystems. This design is taken into account for the TNC 640 control, as well as for safety-related position encoders. Two redundant, mutually independent safety channels form the basis of the controls with functional safety (FS). All safety-relevant signals are captured, processed, and output via two channels. Errors are detected through the mutual comparison of the states and data of both channels. Therefore, the occurrence of a single error in the control does not result in a loss of the safety function.</p>
Structure	<p>The safety-related controls from HEIDENHAIN have a dual-channel design with mutual monitoring. The SPLC (safety-related PLC program) and SKERN (safety kernel software) software processes are the basis of the two redundant systems. The two software processes run on the MC main computer (CPU) and CC controller unit components. The dual-channel structure through MC and CC is continued in the PLB 6xxx FS input/output systems and the MB 720 FS. This means that all safety-relevant signals (e.g., permissive buttons and keys, door contacts, emergency stop button) are captured via two channels and are evaluated independently of each other by the MC and CC. The MC and CC use separate channels to also address the power modules and to stop the motors in case of an error.</p>
Components	<p>In systems with functional safety, certain hardware components assume safety-relevant tasks. Systems with FS must consist of only those safety-relevant components, including their variants, that HEIDENHAIN has approved for use!</p> <p>Control components with functional safety are indicated by the suffix “FS” following the model designation (e.g., MB 72x FS).</p>
MB and TE	<p>An MB machine operating panel with functional safety (FS) is indispensable for systems with FS. Only on such a machine operating panel do all keys have a dual-channel design. Axes can be moved without additional permissive keys.</p>
PLB	<p>In systems with functional safety (FS), a combination of hardware (FS and standard) is possible, but a PLB 62xx FS is mandatory.</p>
HR	<p>FS handwheels are required in systems with functional safety because only they have the required cross-circuit-proof permissive buttons.</p> <p>For a current list of components approved for FS, see the <i>Functional Safety FS Technical Manual</i>.</p>

Safety functions

The following safety functions are integrated into the hardware and software:

- Safe stop reactions (SS0, SS1, and SS2)
- Safe torque off (STO)
- Safe operating stop (SOS)
- Safely limited speed (SLS)
- Safely limited position (SLP)
- Safe brake control (SBC)
- Safe operating modes
 - Operating mode 1: Automated or production mode
 - Operating mode 2: Set-up mode
 - Operating mode 3: Manual intervention
 - Operating mode 4: Advanced manual intervention, process monitoring

Please note:

Full functionality is not yet available for all machine types with functional safety (FS). Before planning a machine with functional safety, please inform yourself of whether the current scope of features suffices for your machine design.

Activation of functional safety (FS)

If the control identifies a PLB 62xx FS in the system during booting, functional safety (FS) is activated.

In this case, it is essential that the following prerequisites be fulfilled:

- FS version of safety-relevant control components (e.g. TE 745 FS, HR 550 FS)
- Safety-related SPLC program
- Configuration of safe machine parameters
- Wiring of the machine for systems with functional safety

Functional safety (FS) cannot be activated or deactivated by parameter.

For more information

For more information on the topic of functional safety (FS), refer to the Technical Information documents *Safety-Related Control Technology for Machine Tools* and *Safety-Related Position Encoders*.

For details, see the *Functional Safety FS* Technical Manual. Your contact person at HEIDENHAIN will be glad to answer any questions concerning controls with functional safety (FS).

Control systems with external safety

Basic principle

In control systems without integrated functional safety (FS), no integrated safety functions, such as safe operating modes, safe speed monitoring, or safe operating stop, are available. Such functions must be implemented entirely with the help of external safety components.

Control systems without integrated functional safety (FS) solely support the realization of the safety functions STO (safe torque off: dual-channel interruption of the motor power supply) and SBC (safe brake control: dual-channel triggering of the motor holding brakes). The dual-channel redundancy of the functions must be realized by the OEM through appropriate wiring.

Operating system

HEROS 5

The TNC 640 and PNC 610 work with the real-time capable HEROS 5 operating system (HEIDENHAIN Realtime Operating System). This future-oriented operating system contains the following powerful functions as part of its standard repertoire:

Network

- Network: management of network settings
- Remote Desktop Manager: management of remote applications
- Printer: management of printers
- Shares: management of network shares
- VNC: virtual network computing server

Safety

- Portscan (OEM): port scanner
- Firewall: protection against undesired network access
- SELinux: protection against unauthorized changes to system files
- Sandbox: running applications in separated environments

System

- Backup/Restore: function for backing-up and restoring the software on the control
- HELogging: evaluation and creation of log files
- Perf2: system monitor
- User administration: define users with different roles and access permissions

Tools

- Web browser: Firefox®*
- Document Viewer: display PDF, TXT, XLS, and JPEG files
- File Manager: file explorer for managing files and memory media
- Gnumeric: spreadsheet calculations
- Leafpad: text editor for creating notes
- Ristretto: display of image files
- Orage Calendar: simple calendar function
- Screenshot: creation of screendumps
- Totem: media player for playing audio and video files

User administration

The improper operation of a control often leads to unplanned machine downtime and costly scrap. The user administration feature can significantly improve process reliability through the systematic avoidance of improper operation. Through the configurable linkage of rights with user roles, access can be tailored to the activities of the respective user.

- Logging on to the control with a user account
- User-specific HOME folder for simplified data management
- Role-based access to the control and network data

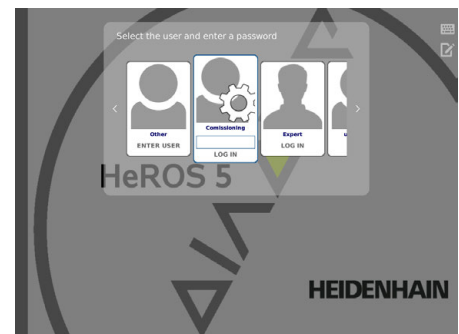

* Firefox is a registered trademark of the Mozilla Foundation

Axes

Linear axes

Depending on its configuration, the TNC 640 can control linear axes with any axis designation (X, Y, Z, U, V, W, ...).

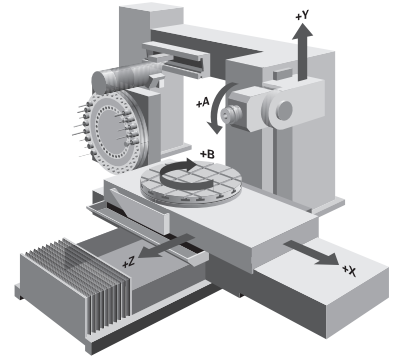

Display and programming

–99 999.99999 to +99 999.99999 [mm]

Feed rate in mm/min relative to the workpiece contour, or mm per spindle revolution

Feed rate override: 0 % to 150 %

Traverse range

–99 999.99999 to +99 999.99999 [mm]

The machine tool builder defines the traverse range. The user can set additional limits to the traverse range if he wishes to reduce the working space. Three different traverse ranges can be defined (selection via PLC).

Rotary axes

The TNC 640 can control rotary axes with any axis designation (A, B, C, U, ...). Special parameters and PLC functions are available for rotary axes with Hirth coupling.

Display and programming

0° to 360° or
–99 999.99999 to +99 999.99999 [°]

Feed rate in degrees per minute [°/min]

Traverse range

–99 999.99999 to +99 999.99999 [°]

The machine tool builder defines the traverse range. The user can set additional limits to the traverse range if he wishes to reduce the working space. Various traverse ranges can be defined via parameter sets for each axis (selection via PLC).

Free rotation

For milling-turning operations, the rotary axis can be started via the PLC with a defined feed rate. For functions specific to milling-turning machines, see *Turning operations*.

Cylinder Surface Interpolation (software option 8)

A contour defined in the working plane is machined on a cylindrical surface.

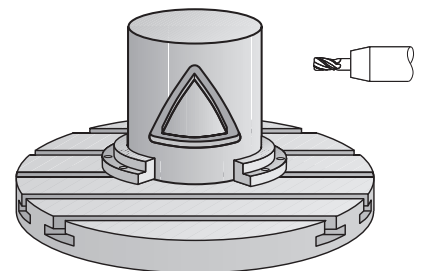

Tilting the Working Plane (software option 8)

The TNC 640 has special coordinate transformation cycles for controlling swivel heads and tilting tables. The tool lengths and offset of the tilting axes are compensated for by the TNC.

The TNC can manage more than one machine configuration (e.g., different swivel heads).

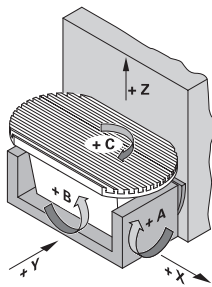

Tilting table

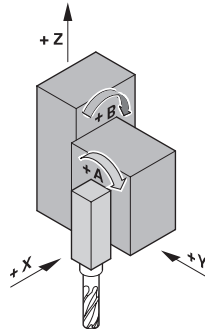

Swivel head

5-Axis Machining (software option 9)

Tool Center Point Management (TCPM)

The offset of the tilting axes is compensated for in a manner such that the position of the tool tip relative to the contour is maintained. Even during machining, handwheel positioning commands can be superimposed such that the tool tip remains on the programmed contour.

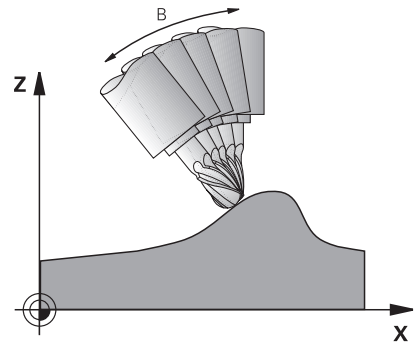

Synchronized Axes

Synchronized axes move in synchronism and are programmed with the same axis designation.

With HEIDENHAIN controls, parallel axis systems (gantry axes), such as on portal-type machines or tilting tables, can be moved synchronously to each other through high-accuracy and dynamic position control.

In the case of **gantry axes**, multiple gantry slave axes can be assigned to a single master axis. They may also be distributed to multiple controller units.

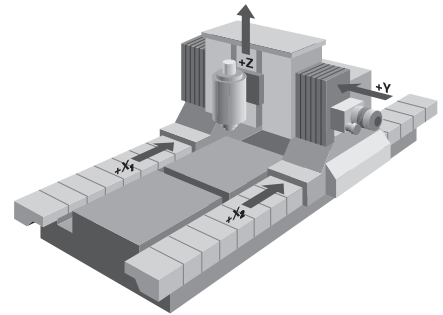

Torque Control

Torque control is used on machines with mechanically coupled motors, for which

- a defined distribution of drive torque is desired, or
- parts of the controlled system show a backlash effect that can be eliminated by "tensioning" the motors (e.g. toothed racks).

For torque control, the master and slave must be on the same controller motherboard. Depending on the controller unit being used, up to five slave axes can thereby be configured for each master.

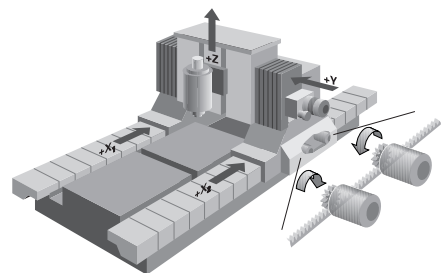

Real-Time Coupling Function (software option 135)

The real-time coupling function (synchronizing functions) allows the cyclic calculation of a position offset for an axis from the actual and nominal values of any other axes in the system. This enables you to realize complex simultaneous movements of several NC or PLC axes. The mutual dependence of the axes is defined in mathematical formulas.

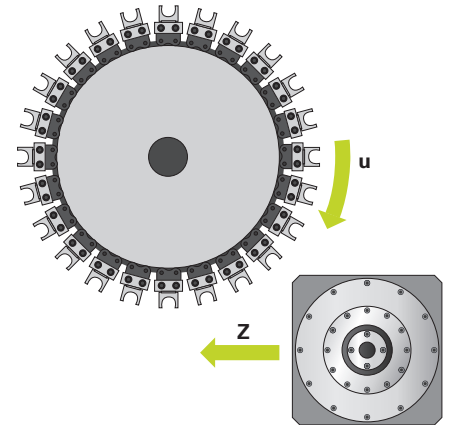

Batch Process Manager (software option 154)

Batch Process Manager provides functions for the planning and execution of multiple production jobs on the TNC. It makes it possible to easily edit pallets and to alter the sequence of pending jobs. Batch Process Manager also performs a duration calculation for all planned jobs or NC programs. It informs the user as to whether, for example, all NC programs can be executed without error or whether all required tools are available with sufficient tool life. Batch Process Manager thereby ensures the smooth execution of the planned jobs. Batch Process Manager also requires software option 22 (Pallet Management) to be enabled.

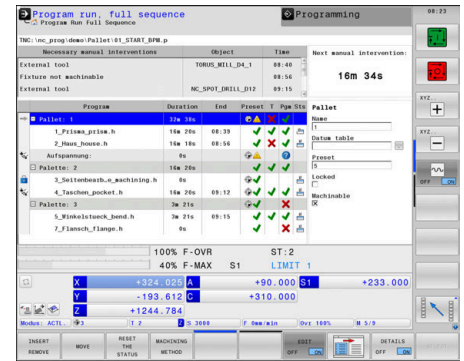

Global PGM Settings (software option 44)

The functions provided by global program settings allow adaptation of the machining process without changing the original NC program. This makes it easy to mirror axes or activate additional offsets, for example. The TNC 640 also provides the ability to use handwheel superimpositioning in various coordinate systems and utilize virtual tool axes. This function is typically employed in toolmaking and mold manufacturing.

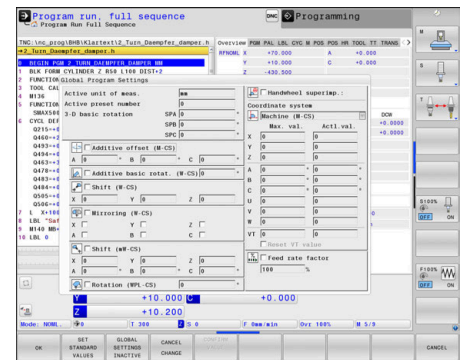

PLC axes

Axes can be defined as PLC axes. Programming is performed through M functions or OEM cycles. The PLC axes are positioned independently of the NC axes and are therefore designated as asynchronous axes.

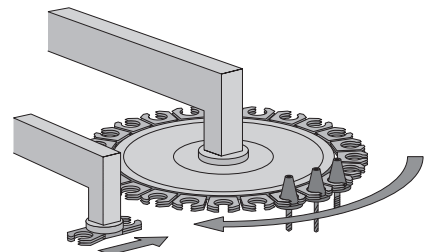

Turning

Performing Turning Operations (software option 50)

The TNC 640 supports machines that can perform a combination of milling and turning operations in a single setup. It offers the operator a comprehensive package of cycles for both types of operations, which are programmed in HEIDENHAIN's shopfloor-oriented Klartext format. Rotationally symmetric contours are produced during turning operations. The preset must be in the center of the lathe spindle for this.

In turning mode, the rotary table serves as the lathe spindle, while the milling spindle with the tool remains stationary. Milling-turning machines are subject to special demands. A basic prerequisite is a machine designed with high rigidity so as to ensure a low oscillation tendency even when the machine table (acting as a lathe spindle) is turning at high speeds.

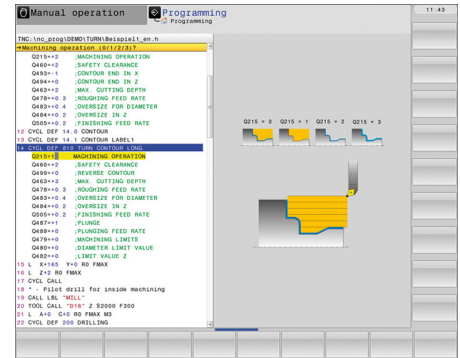

Toggleing between milling and turning modes

During the transition between milling and turning mode, the TNC switches diameter programming on or off, selects the XZ working plane for turning, and displays "Milling" and "Turning" mode in the status display.

The user switches between turning and milling mode with the NC command FUNCTION MODE TURN or FUNCTION MODE MILL. The machine-specific procedures necessary for this are realized via OEM macros. In these macros, the OEM defines, for example, which kinematic model is active for the turning or milling operation, and which axis and spindle parameters take effect in milling or turning mode. Because the FUNCTION MODE TURN and FUNCTION MODE MILL commands are independent of the machine model, NC programs can be exchanged between different types of machines.

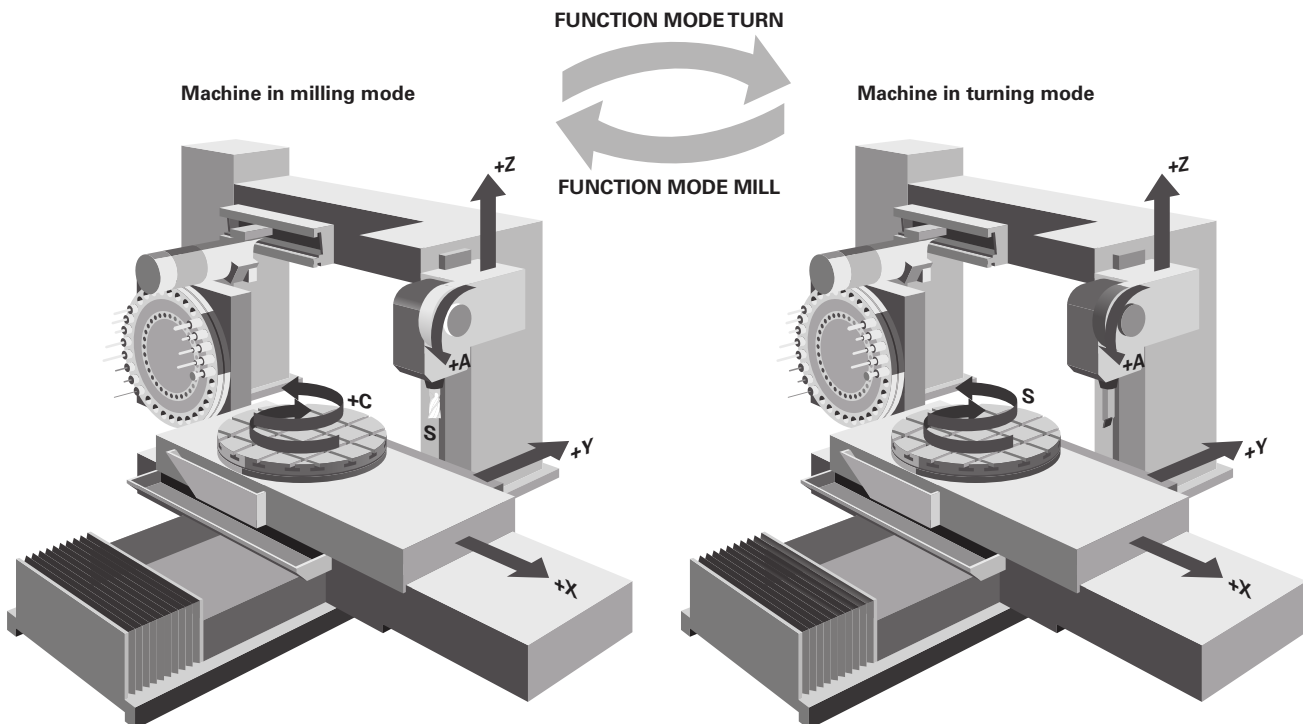

Support for facing slides (facing heads)

With complete support for facing slides, the TNC 640 provides a further way of performing turning operations on a milling machine. A longitudinal turning tool, for example, can be mounted to the facing slide and called with a TOOL CALL block. Even complex turning operations are programmed with familiar ease using cycles. Machining operations with the facing slide can be carried out with the TNC 640 in any inclination (PLANE functions). In addition, numerous useful turning functions, such as constant cutting speed, are available. The use of facing slides requires the enabling of software option 50 for turning operations on the TNC 640.

Measuring unbalance and balancing

An important and basic prerequisite for turning operations is that the radial runout of the workpiece has been balanced. Both the machine (rotary table) and the workpiece must be balanced before machining. If the clamped workpiece has an unbalance, undesirable centrifugal forces can result, thereby influencing the accuracy of the runout.

An unbalance on the rotary table can endanger the safety of the user and has a negative effect on the quality of the workpiece and the service life of the machine.

The TNC 640 can detect an unbalance in the rotary table based on the effects of the centrifugal forces on neighboring linear axes. To this end, the rotary table should ideally be positioned via a linear axis. For other machine designs, unbalance detection by means of external sensors lends itself as a solution.

The TNC 640 features the following functions:

• **Unbalance calibration**

A calibration cycle determines the unbalance behavior of the rotary table. This unbalance calibration is generally performed by the OEM before the machine is shipped. During execution of the calibration cycle, the TNC generates a table describing the unbalance behavior of the rotary table.

• **Balancing**

After the blank to be turned has been set up, the user can ascertain the unbalance using a measuring cycle. During balancing, the TNC supports the user by displaying the mass and position of the balancing weights.

• **Unbalance monitoring**

During the machining operation, the TNC continually monitors the unbalance. An NC stop is triggered if a specified limit value is exceeded.

Gear Cutting (software option 157)

The Gear Cutting software option provides user-friendly cycles for the economical production of external and internal gear teeth. The hobbing and skiving cycles enable the complete machining of high-quality gear teeth in a single setup, including static shifting for prolonged tool life and synchronous shifting for the production of helical gear teeth.

Advanced Function Set Turning (software option 158)

The Advanced Function Set Turning option expands the package of turning cycles to include Cycle 883 (TURNING SIMULTANEOUS FINISHING). This cycle enables the finishing of complex contours in a single run so as to avoid visible transitions.

Grinding operations

Grinding (software option 156)

With its Grinding option, the TNC 640 supports jig grinding technology for the fine finishing of 2-D contours.

Grinding operations are programmed with the familiar HEIDENHAIN Klartext dialog guidance. Convenient cycles are available to the user. Instead of a milling cutter, jig grinding employs a grinding tool (e.g., grinding pin) for material removal. Since machining is performed in milling mode, a separate operating mode is not needed.

A stroke movement or oscillating movement in the tool axis can be activated by means of a cycle. There is also the capability of dressing or truing-up grinding tools inside the machine.

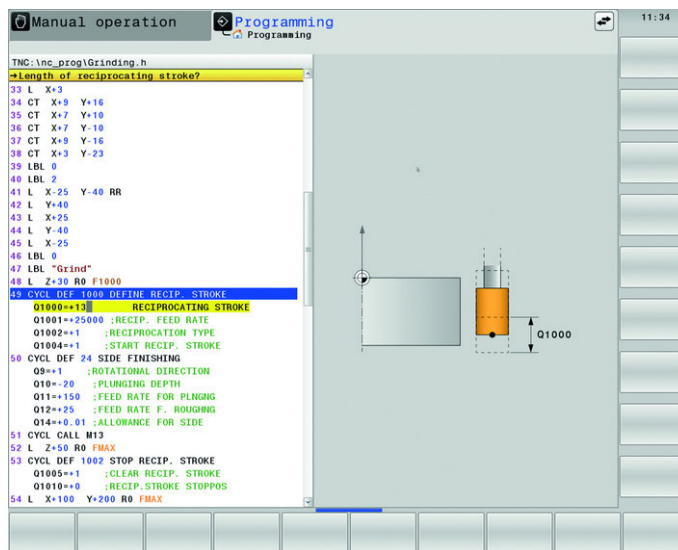

Spindle

Overview	The TNC 640 contouring control is used in conjunction with the HEIDENHAIN inverter systems with field-oriented control. As an alternative, an analog nominal speed value can be output.
Controller unit	With the CC controller units and the UEC/UMC inverters, a fundamental PWM frequency can be set for each controller assembly (e.g., 4 kHz). Possible fundamental frequencies are 3.33 kHz, 4 kHz, or 5 kHz. With software option 49 (Double-Speed), this frequency can be increased to up to 16 kHz for high-speed spindles (e.g., for HF spindles). See the <i>Technical Manual</i> .
Controller groups	For example with CC 6106 1: X51 + X52 2: X53 + X54 3: X55 + X56
Maximum spindle speed	The maximum spindle speed is calculated as follows: $n_{\max} = \frac{f_{\text{PWM}} \cdot 60000 \text{ rpm}}{\text{NPP} \cdot 5000 \text{ Hz}}$ $f_{\text{PWM}} =$ PWM frequency in Hz $\text{NPP} =$ Number of pole pairs
Operating mode switchover	For controlling the spindle, different parameter sets can be saved for closed-loop control (e.g., for wye or delta connections). You can switch between the parameter sets in the PLC.
Position-controlled spindle	The position of the spindle is monitored by the control.
Encoder	HEIDENHAIN rotary encoder with sinusoidal voltage signals (1 V _{pp}) or EnDat interface.
Tapping	There are special cycles for tapping with or without a floating tap holder. For tapping without a floating tap holder, the spindle must be operated under position control.
Spindle orientation	With a position-controlled spindle, the spindle can be positioned exactly to 0.1°.
Spindle override	0 % to 150 %
Gear ranges	A separate nominal speed is defined for each gear range. The gear code is output via the PLC.
Multiple main spindles	Up to four spindles can be controlled alternately. The spindles are switched by the PLC. One control loop is required for each active spindle.
Spindle Synchronism (software option 131)	The Spindle Synchronism software option allows the speed of two or more spindles to be synchronized. Spindle synchronization is also possible with a transmission ratio or a defined offset.

Encoders

Overview

For speed and position control of the axes and spindle, HEIDENHAIN offers both incremental and absolute encoders.

Incremental encoders

Incremental encoders have as their measuring standard a grating consisting of alternating lines and spaces. Relative movement between the scanning head and the scale causes the output of sinusoidal scanning signals. The measured value is calculated by counting the signals.

Reference mark

When the machine is switched on, the machine axes need to traverse a reference mark for an accurate reference to be established between the measured value and the machine position. For encoders with distance-coded reference marks, the maximum travel until automatic reference mark evaluation for linear encoders is only 20 mm or 80 mm, depending on the model, or 10° or 20° for angle encoders.

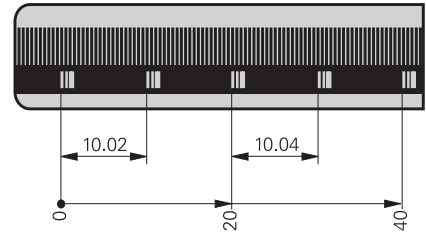

Evaluation of reference marks

The routine for traversing the reference marks can also be started for specific axes via the PLC during operation (reactivation of parked axes).

Output signals

Incremental encoders with sinusoidal output signals with $\sim 1 V_{PP}$ levels are suitable for connection to HEIDENHAIN numerical controls.

Absolute encoders

With absolute encoders, the position information is contained in several coded tracks. Thus, an absolute reference is available immediately after switch-on. A reference-mark traverse is not necessary. Additional incremental signals are output for highly dynamic control loops.

EnDat interface

The TNC 640 features the serial EnDat 2.2 interface (includes EnDat 2.1) for the connection of absolute encoders.

Note: The EnDat interface on HEIDENHAIN encoders differs in its pin assignment from the interface on Siemens motors with integrated absolute ECN/EQN rotary encoders. Special adapter cables are available.

Encoder inputs

Incremental and absolute linear, angle, or rotary encoders from HEIDENHAIN can be connected to all **position encoder** inputs of the controller unit.

Incremental and absolute rotary encoders from HEIDENHAIN can be connected to all **speed encoder** inputs of the controller unit.

Inputs	Signal level/ Interface ¹⁾	Input frequency ¹⁾	
		Position	Speed
Incremental signals	$\sim 1 V_{PP}$ EnDat 2.1	33 kHz/350 kHz	350 kHz
Absolute position values	EnDat 2.1 EnDat 2.2	–	–

¹⁾ Switchable

Digital servo control

Integrated inverter Position controllers, speed controllers, current controllers, and inverters are integrated into the TNC 640. HEIDENHAIN synchronous or asynchronous motors are connected to the TNC 640.

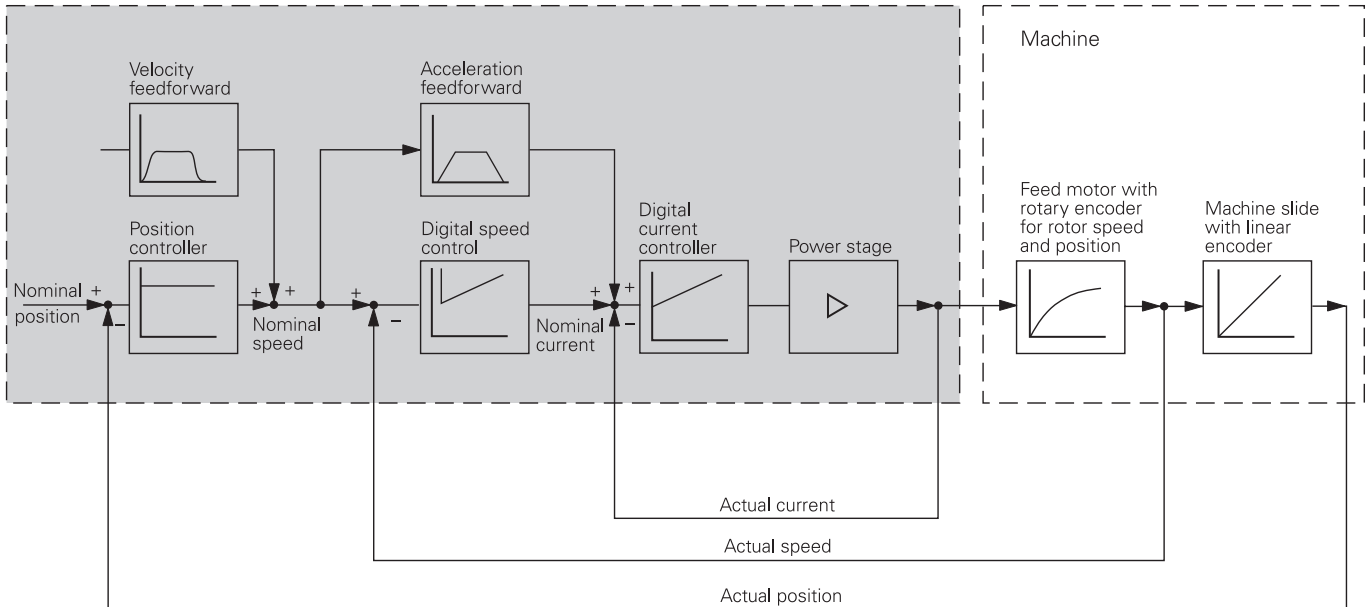

Axis feedback control The TNC 640 can be operated with following error or feedforward control. During roughing operations at high speeds, for example, you can switch to velocity semi-feedforward control via an OEM cycle in order to machine faster at reduced accuracy.

Operation with following error The term "following error" denotes the distance between the momentary nominal position and the actual position of the axis. The velocity is calculated as follows:

$$v = k_v \cdot s_a$$

v = Velocity
 k_v = Position loop gain
 s_a = Following error

Operation with feedforward control Feedforward means that a given velocity and acceleration are adapted to the machine. Together with the values calculated from the following error, this given velocity and acceleration becomes the nominal value. A much lower following error thereby manifests itself (in the range of only a few microns).

Compensation of torque ripples The torque of synchronous, torque, and linear motors is subject to periodic oscillations, one cause of which can be permanent magnets. The amplitude of this torque ripple depends on the motor design, and under certain circumstances can have an effect on the workpiece surface. After the axes have been commissioned with the TNCopt software, the Torque Ripple Compensation (TRC) of the CC 61xx or UEC 11x can be used to compensate for it.

Control loop cycle times

The cycle time for **path interpolation** is defined as the time interval during which interpolation points on the path are calculated. The cycle time for **fine interpolation** is defined as the time interval during which interpolation points are calculated that lie within the interpolation points calculated for path interpolation. The cycle time for the **position controller** is defined as the time interval during which the actual position value is compared to the calculated nominal position value. The cycle time for the **speed controller** is defined as the time interval in which the actual speed value is compared to the calculated nominal speed value. The **cycle time for the current controller** is defined as the time interval during which the actual value of the electrical current is compared to the calculated nominal value of the electrical current.

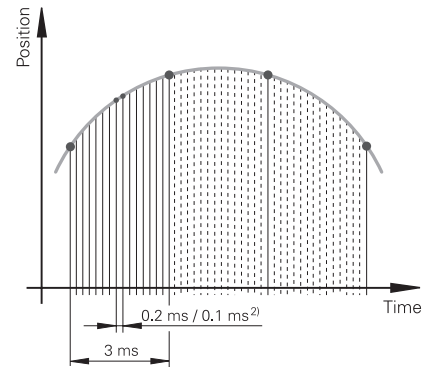

	CC/UEC/UMC
Path interpolation	3 ms
Fine interpolation	0.2 ms/0.1 ms ¹⁾ at $f_{PWM} = 5000$ Hz
Position controller	0.2 ms/0.1 ms at $f_{PWM} = 5000$ Hz
Speed controller	0.2 ms/0.1 ms ¹⁾ at $f_{PWM} = 5000$ Hz
Current controller	0.1 ms at $f_{PWM} = 5000$ Hz

¹⁾ Double speed (with software option 49)

Axis clamping

The control loop can be opened through the PLC in order to clamp specific axes.

Double Speed Control Loops (software option 49)

Double-speed control loops permit higher PWM frequencies and shorter cycle times for the speed controller. This enables improved current control for spindles and higher controller performance for linear and torque motors.

Crossover Position Filter (CPF)

To increase the stability of the position control loop in systems with resonances, the position signal from the position encoder, which is filtered through a low-pass filter, is combined with the position signal from the motor speed encoder, which is filtered through a high-pass filter. This signal combination is made available to the position controller as the actual position value. The possible position controller gain (k_v factor) is increased significantly by this. The filter separation frequency is set specifically for each axis via machine parameters. The CPF can be used only in dual-encoder systems on motors with speed and position encoders.

Fast contour milling

Short block processing time

The TNC 640 provides the following important features for fast contour machining.

The block processing time of the MC is 0.5 ms. This means that, during the execution of long programs from the hard drive, the TNC 640 can even mill contours approximated in 0.2 mm line segments at a feed rate of up to 24 m/min.

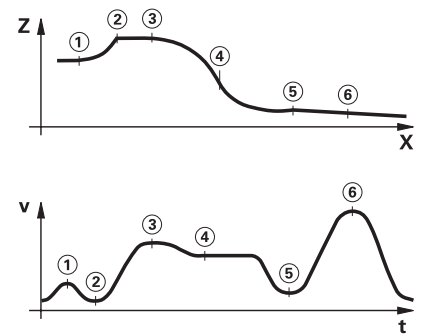

Look-ahead

For feed rate adaptation, the TNC 640 performs a precalculation of the geometry (max. 5000 blocks). In this way, directional changes are detected in time to accelerate or decelerate the appropriate NC axes.

Jerk

The derivative of acceleration is referred to as jerk. A linear change in acceleration causes a jerk step. Such motion sequences may cause the machine to oscillate.

Jerk limiting

To prevent machine oscillations, the jerk is limited in order to attain optimum path control.

Smoothed jerk

The jerk is smoothed by nominal position value filters. The TNC 640 therefore mills smooth surfaces at the highest possible feed rate and yet keeps the contour accurate. The operator programs the permissible tolerance in a cycle. Special filters for HSC machining (HSC filters) can specifically suppress the natural frequencies of an individual machine. The desired accuracy and a very high surface quality are attained.

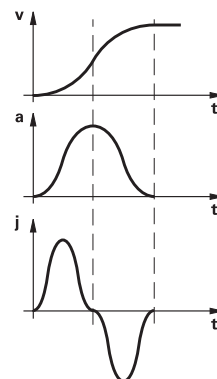

Advanced Dynamic Prediction (ADP)

The Advanced Dynamic Prediction (ADP) function enhances the conventional look-ahead of the permissible maximum feed rate profile, thereby enabling optimized motion control for clean surface finishes and perfect contours. The strengths of ADP are evident, for example, during bidirectional finish milling through symmetrical feed behavior on the forward and reverse paths, as well as through particularly smooth feed rate curves on parallel milling paths. NC programs that are generated on CAM systems have a negative effect on the machining process due to various factors such as short, step-like contours; coarse chord tolerances; and heavily rounded end-point coordinates. Through an improved response to such factors and the exact adherence to dynamic machine parameters, ADP not only improves the surface quality of the workpiece but also optimizes the machining time.

Dynamic Efficiency

Overview

With the concept of Dynamic Efficiency, HEIDENHAIN offers innovative TNC functions that help the user make heavy machining and roughing more efficient while also enhancing its process reliability. Dynamic Efficiency permits higher removal rates and therefore increases productivity. At the same time, it prevents any tool overloading and the concomitant premature cutter wear.

Dynamic Efficiency comprises three software functions:

- **ACC** (Active Chatter Control): this software option reduces chatter susceptibility, thus enabling higher feed rates and infeeds.
- **AFC** (Adaptive Feed Control): this software option controls the feed rate based on the machining situation.
- **Trochoidal milling**: a function for the roughing of slots that eases the load on the tool
- **OCM** (Optimized Contour Milling): the OCM software option allows pockets and islands of any shape to be machined with low tool wear using the highly efficient trochoidal milling method.

Each solution in itself offers decisive advantages in the machining process. But the combination of these TNC features, in particular, exploits the potential of the machine and tool and at the same time reduces the mechanical load.

Adaptive Feed Control (AFC), software option 45

With Adaptive Feed Control (AFC), the contouring feed rate is controlled based on the respective percentage of spindle power.

Benefits of adaptive feed control:

- Optimization and reduction of machining time
- Prevention of subsequent damage through tool monitoring
- Automatic insertion of a replacement tool when the tool is worn (machine-dependent function)
- Protection of the machine mechanics
- Documentation by capturing and saving the learning and process data
- Integrated NC function, and therefore an alternative to external software solutions

Restrictions:

AFC cannot be used for analog spindles or in volts-per-hertz control mode.

dynamic + efficiency

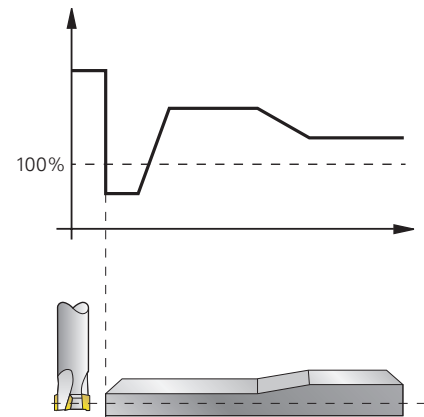

Active Chatter Control (ACC), software option 145

During heavy machining (roughing at a high removal rate), strong milling forces arise. Depending on the tool spindle speed, the resonances in the machine tool, and the chip volume (metal-removal rate during milling), the phenomenon known as "chatter" may occur. Chatter puts the machine under heavy strain and causes blemishes on the workpiece surface. Tool wear is also accelerated and less evenly distributed. In extreme cases, the tool may even break. To reduce chatter susceptibility, HEIDENHAIN now offers an effective remedy through its Active Chatter Control (ACC) option. This option is particularly beneficial during heavy machining. ACC enables substantially higher cutting performance: depending on the machine model, the metal removal rate can be increased by 25 % or more. Thus, you can reduce the load on your machine while simultaneously increasing the life of your tools.

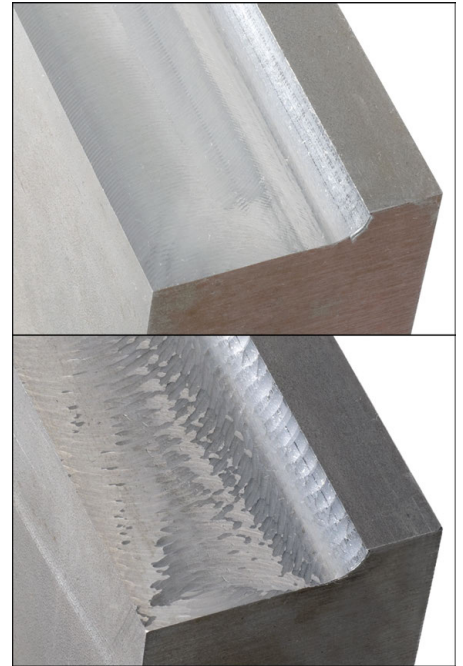

Top figure: part milled with ACC

Bottom figure: part milled without ACC

Optimized Contour Milling (OCM), software option 167

With Optimized Contour Milling (OCM), you can machine pockets and islands of any shape while reducing tool wear thanks to highly efficient trochoidal milling. You simply program the contour as usual directly in Klartext or make use of the convenient CAD Import function. The control then automatically calculates the complex movements required for trochoidal milling.

Advantages of OCM over conventional machining:

- Reduced thermal load on the tool
- Superior chip removal
- Uniform tool-workpiece contact
- Higher possible cutting parameters
- Higher removal rates
- No need for adjustments by the machine tool builder

Dynamic Precision



Overview

The umbrella term Dynamic Precision encompasses a number of HEIDENHAIN milling solutions that significantly improve the dynamic accuracy of a machine tool. The dynamic accuracy of machine tools can be seen in the errors at the tool center point (TCP). The size of these errors depends on the magnitudes of the motion (e.g., speed and acceleration, as well as jerk) and result from the vibrations of the machine components, among other things. Taken together, all of these errors are partially to blame for dimensional errors and faults on the surfaces of workpieces. They therefore have a decisive impact on quality and, in the event of quality-related scrap, on productivity as well.

Because the stiffness of machine tools is limited for reasons of design and economy, problems such as compliance and vibration within the machine design are very difficult to avoid. Dynamic Precision counteracts these problems with intelligent control technology to enable designers to further improve the quality and dynamic performance of machine tools. This saves time and money in production.

The software options that make up Dynamic Precision can be deployed by the machine manufacturer both alone or in combination:

- **CTC:** compensates for acceleration-dependent position errors at the tool center point, thereby increasing accuracy during acceleration phases
- **AVD:** active vibration damping improves surfaces
- **PAC:** position-dependent adaptation of control parameters
- **LAC:** load-dependent adaptation of control parameters enhances accuracy regardless of load and aging
- **MAC:** motion-dependent adaptation of control parameters

Load Adaptive Control (LAC), software option 143

With LAC (software option 143), you can dynamically adjust controller parameters based on the load or friction.

The dynamic behavior of machines with rotary tables can vary depending on the mass moment of inertia of the fixed workpiece. The Load Adaptive Control (LAC) software option allows the control to automatically determine the current mass moment of inertia of the workpiece and the current frictional forces.

In order to optimize changed control behavior at differing loads, adaptive feedforward controls can exploit data on acceleration, holding torque, static friction, and friction at high shaft speeds.

Motion Adaptive Control (MAC), software option 144

Along with the position-based modification of machine parameters through the PAC software option, the Motion Adaptive Control (MAC) software option allows machine parameters to be changed based on their initial values, such as speed, following error, or acceleration. Through this motion-dependent adaptation of the control parameters, a speed-dependent adaptation of the k_v factor can be implemented for drive systems whose stability changes due to the different traversing speeds.

Cross Talk Compensation (CTC), software option 141

CTC (software option 141) enables the compensation of dynamic position errors potentially arising from acceleration forces.

To increase productivity, machine tool users are asking for ever higher feed rates and accelerations, while at the same time they need to maintain the highest possible surface quality and accuracy, placing very special requirements on path control.

Highly dynamic acceleration processes introduce forces to the structure of a machine tool. They can deform parts of the machine and thereby lead to deviations at the tool center point (TCP). Besides deformation in the direction of the axis, the dynamic acceleration of an axis due to mechanical axis coupling can also result in the deformation of axes that are perpendicular to the direction of acceleration. The resulting position error at the TCP in the direction of the accelerated axis and lateral axes is proportional to the amount of acceleration.

If the dynamic position errors relative to the axis acceleration are known, then these acceleration-dependent errors can be compensated for by the Cross Talk Compensation (CTC) software option in order to avoid negative effects on the surface quality and accuracy of the workpiece. Often, the resulting error at the TCP depends not only on the acceleration but also on the position of the axes in the working space. This can also be compensated for by CTC.

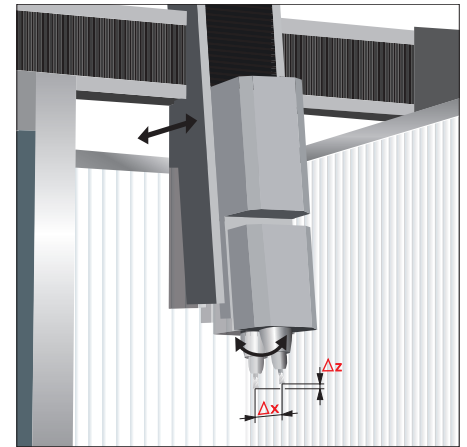

Active Vibration Damping (AVD), software option 146

The high dynamics of modern machine tools lead to deformations in the machine base, frame, and drive train during acceleration and deceleration of the feed motors. This results in vibrations, such as machine setup vibrations, that may reduce the attainable accuracy and surface quality of the workpieces. The Active Vibration Damping (AVD) controller function dampens the especially critical low-frequency oscillations and optimizes the control behavior of the affected axis at the same time so that high-accuracy workpieces with increased surface quality can also be produced at high feed rates. The improved rigidity attained can be used to increase the dynamic limit values (e.g., jerk), and therefore makes reduced machining times possible.

Position Adaptive Control (PAC), software option 142

PAC (software option 142) permits the dynamic, position-dependent adaption of controller parameters based on the spatial position of the tool.

The specifics of a machine's kinematics cause a unique position of the axes' center of gravity in the working space. This results in a variable dynamic behavior of the machine, which can negatively influence the control's stability depending on the axis positions.

To take full advantage of the machine's dynamic performance, the Position Adaptive Control (PAC) software option enables changes to machine parameters based on position, thus permitting assignment of the respective optimal loop gain to defined interpolation points. Additional position-dependent filter parameters can be defined in order to further increase control loop stability.

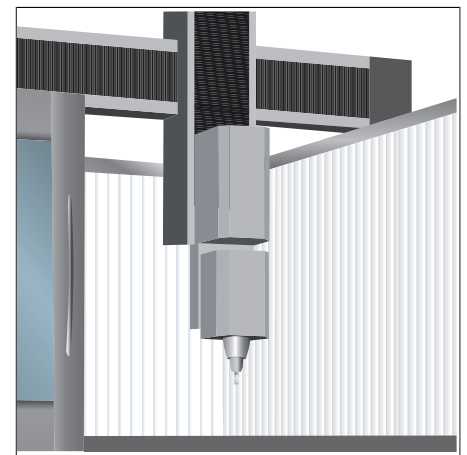

Monitoring functions

Description

During operation, the control monitors the following details*:

- Amplitude of the encoder signals
- Edge separation of the encoder signals
- Absolute position from encoders with distance-coded reference marks
- Current position (following error monitoring)
- Actual distance traversed (movement monitoring)
- Position deviation at standstill
- Nominal speed value
- Checksum of safety-related functions
- Supply voltage
- Voltage of the backup battery
- Operating temperature of the MC and CPU
- Run time of the PLC program
- Motor current / motor temperature
- Temperature of the power module
- DC-link voltage

With EnDat 2.2 encoders:

- The CRC checksum of the position value
- EnDat alarm Error1 → EnDat status alarm register (0xEE)
- EnDat alarm Error2
- Edge speed of 5 μs
- Transmission of the absolute position value on the time grid

In the event of hazardous errors, an emergency stop message is sent to the external electronics via the control-is-ready output, and the axes are brought to a stop. The correct connection of the TNC 640 in the machine's emergency stop loop is checked when the control system is switched on. In the event of an error, the control displays a message in plain language.

* No safety functions

Dynamic Collision Monitoring (DCM), software option 40

With the Dynamic Collision Monitoring (DCM) software option, the TNC cyclically monitors the working space of the machine for possible collisions between machine components. To this end, the OEM must define three-dimensional collision objects in the working space that are to be monitored by the TNC during all machine movements, including those of the swivel head and tilting table. If two objects monitored for collision come within a defined distance of each other, the TNC outputs an error message. At the same time, the affected machine components are shown in red in the machine image. Collision monitoring is active in the manual operating modes and in the machine operating modes, and is indicated by a symbol in the operating mode line.

Please note:

- Collision objects (including fixtures) are defined exclusively by the OEM
- The collision of machine parts (e.g., the swivel head) with the workpiece cannot be detected
- Collision objects are not automatically transformed into rotationally symmetric objects in turning mode
- In servo-lag operation (no feedforward), DCM is inactive
- It is not possible to check for collisions in Test Run mode

Collision monitoring also protects fixtures and tool carriers from collisions.

The 3-D collision objects are configured with the commissioning software KinematicsDesign.

With the TNC 640, collision objects can also be transferred in M3D format from standard CAD models (e.g., STL) to the control.

Advantages of the M3D format:

- Simple data transfer from already available CAD models
- Fully detailed illustration of machine components
- Greater exploitation of the working space

Context-sensitive help

Context-sensitive help is available to the user through the HELP or ERR buttons. As a result, when there is an error message, the control displays the cause of the error, as well as possible solutions. The machine manufacturer can also implement this user support for PLC error messages.

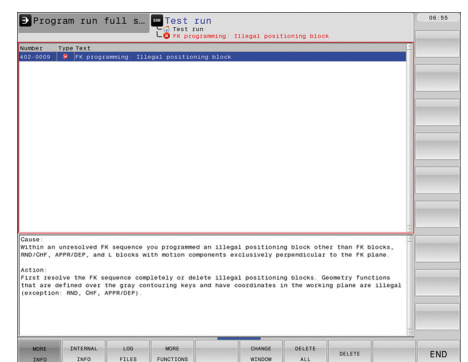
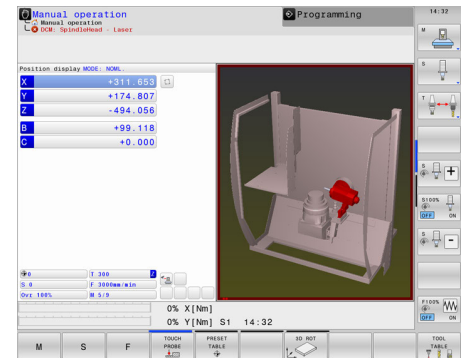

KinematicsDesign (accessory)

KinematicsDesign is a PC program for creating adaptable kinematic configurations. It supports the following:

- Complete kinematic configurations
- Transfer of configuration files between control and PC
- Description of tool-carrier kinematics

Kinematic descriptions created for the iTNC 530 can also be transferred into kinematic descriptions for the TNC 640/620/320/128.

If KinematicsDesign is connected to a control online (operation is also possible with the programming station software), then machine movements can be simulated, and the axes are moved. Together with the TNC 640, KinematicsDesign simulates the working space when DCM is active, and collisions that occur, or machine components in danger of collision, are displayed in a color that you define.

Visualization options range from a pure depiction of the transformation chain and a wire model all the way to the complete machine model.

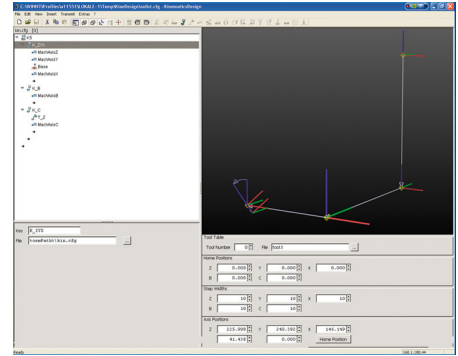

M3D Converter

With the TNC 640, you can transfer collision objects out of a CAD file and integrate them into the machine kinematics using the M3D format. The M3D data format from HEIDENHAIN permits an especially finely detailed depiction of high-resolution collision objects. The M3D converter, which is capable of performing tasks such as checking, repairing, simplifying, merging, and optimizing the CAD data of collision objects, is used to generate the M3D data. As an independent PC tool, the M3D converter is part of the KinematicsDesign installation package (as of version 3.1). The M3D converter requires a software release module (ID 1124969-01).

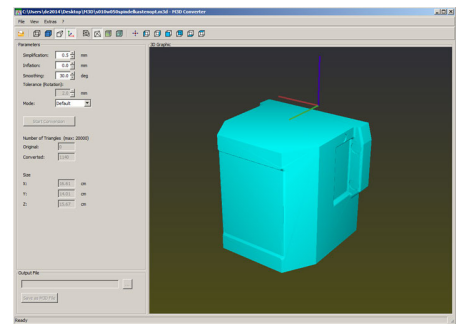

Visual Setup Control (VSC), software option 136

With the Visual Setup Control (VSC) option, the TNC can automatically monitor the current clamping or machining situation while the program is running. To make this possible, the VS 101 camera system takes reference photos of the first parts in a series and compares them with photos of subsequent parts. User-friendly cycles let you specify multiple locations within the NC program at which you want the control to perform a visual comparison between the nominal and actual conditions. If an error is detected, the TNC executes a reaction selected by the user.

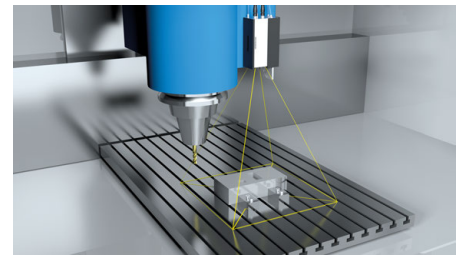

Component Monitoring (software option 155)

The overloading of machine components is often the cause of expensive machine damage and unplanned production downtime. Component monitoring keeps the user informed about the current load on the spindle bearings and reacts upon exceedance of the specified limit values (e.g., with an NC stop).

Error compensation

Overview The TNC 640 automatically compensates for mechanical errors of the machine.

Linear error Linear error can be compensated over the entire travel range for each axis.

Nonlinear error The TNC 640 can compensate for ball-screw pitch errors and sag errors simultaneously. The compensation values are stored in a table. Nonlinear axis-error compensation also makes it possible to compensate for position-dependent backlash.

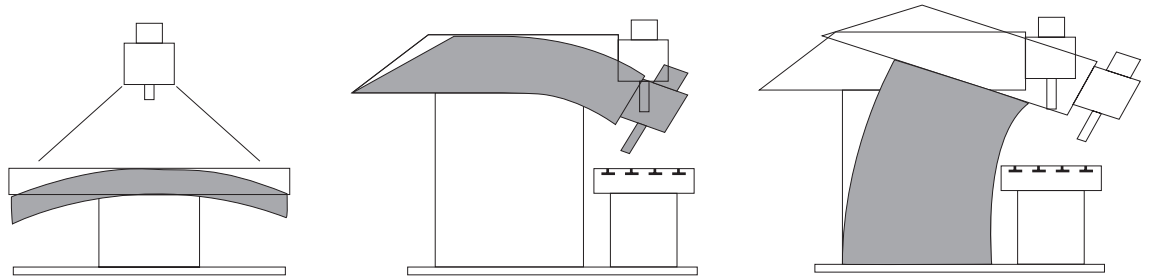

Backlash The play between table movement and rotary encoder movement during direction changes can be compensated for in length measurements by the spindle and rotary encoder. This backlash is outside the controlled system.

Hysteresis The hysteresis between the table movement and motor movement is also compensated for in direct length measurements. In this case, the hysteresis is within the controlled system.

Reversal spikes In circular movements, reversal spikes can occur at quadrant transitions due to mechanical influences. The TNC 640 can compensate for these reversal spikes.

Static friction At very low feed rates, high static friction can cause the slide to stop and start repeatedly for short periods. This is commonly known as stick-slip. The TNC 640 can compensate for this problematic behavior.

Sliding friction Sliding friction is compensated for by the speed controller of the TNC 640.

Thermal expansion To compensate for thermal expansion, the machine's expansion behavior must be known.

The temperature is measured via thermistors connected to the analog inputs of the TNC 640. The PLC evaluates the temperature information and passes a compensation value to the NC.

**KinematicsOpt
(software
option 48)**

Using the KinematicsOpt function, machine tool builders or end users can check the accuracy of rotary or swivel axes and compensate for possible displacements of the center of rotation of these axes. The deviations are automatically transferred to the kinematics description and can be taken into account in the kinematics calculation.

In order to measure the rotary axes, you must attach a calibration sphere (e.g., KKH 100 or KKH 250 from HEIDENHAIN) at any position on the machine table. A HEIDENHAIN touch probe uses a special cycle to probe this calibration sphere and measures the rotary axes of the machine fully automatically. But first you define the resolution of the measurement and define for each rotary axis the range that you want to measure. The measurement results are the same regardless of whether the axis is a rotary table, a tilting table, or a swivel head.

**Calibration
sphere
(accessory)**

HEIDENHAIN offers calibration spheres as accessories for the measurement of rotary axes with KinematicsOpt:

KKH 100	Height: 100 mm	ID 655475-02
KKH 250	Height: 250 mm	ID 655475-01

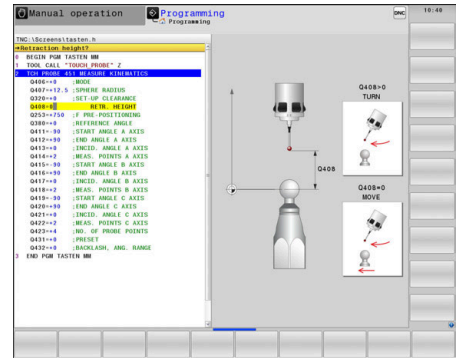

**KinematicsComp
(software
option 52)**

Increasingly stringent requirements on workpiece tolerances constantly increase the demands placed on the precision of a machine tool. However, components of the machine tool inevitably show imperfections that are, for example, caused by manufacturing or installation or result from elastic deformation. This is the reason why the commanded tool position and orientation are not always reached with exactness everywhere in the working space. The more axes a machine has, the more sources of error there are. The use of mechanical means to cope with these problems requires considerable effort, particularly in the field of 5-axis machining, or if large machines with parallel axes are involved.

The KinematicsComp software option allows the OEM to store a comprehensive description of the machine errors in the control. KinematicsComp then automatically compensates for the position error that results from static errors of the physical machine axes (volumetric compensation). The positions of all rotary and linear axes, as well as the current tool length, are included in the calculation. KinematicsComp can continue to be used to define position-dependent temperature compensation. The required data are supplied by multiple sensors located at representative positions on the machine.

For example, the spatial errors of the tool tip can be measured with a laser tracer or laser interferometer. However, multidimensional tables for component errors make it possible to use measured data directly for compensation without building a model. PLC variables as initial values for formulas and multidimensional tables make it easy to enter parameters for powerful compensation, for example, for various thermal conditions or load situations.

The KinematicsComp software option cannot be enabled in the export versions.

**3D-ToolComp
(software
option 92)**

The 3D-ToolComp software option provides 3-D tool radius compensation irrespective of the tool's angle of contact, thus allowing for the compensation of tool form errors. A compensation-value table is used to define angle-dependent delta values. These delta values define the deviation of a tool from its ideal circular form or any deviation in a touch probe's switching behavior. For use with a tool, this function requires surface normal vectors in the NC program, for which the software option Advanced Function Set 2 must be enabled. These compensation values will only be taken into account during probing with a touch probe if new probing cycles (e.g. Cycle 444) are used, which have been prepared for this purpose.

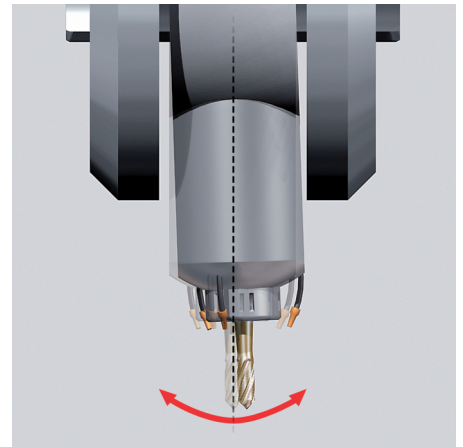

Fault characteristics according to ISO 230-1: EBA

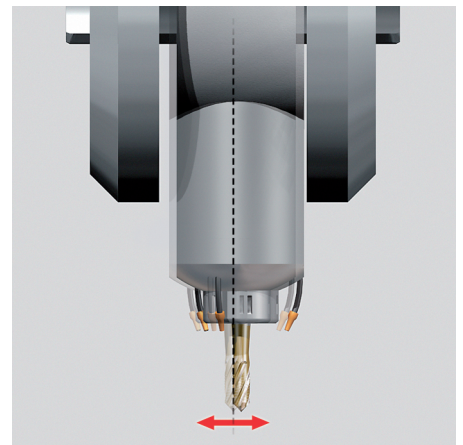

Fault characteristics according to ISO 230-1: EXA

Commissioning and diagnostic aids

Overview

The TNC 640 provides comprehensive internal commissioning and diagnostic aids. It also includes highly effective PC software for diagnostics, optimization, and remote control.

ConfigDesign (accessory)

PC software for configuring the machine parameters

- Stand-alone machine-parameter editor for the control; all supporting information, additional data, and input limits are shown for the parameters
- Configuration of machine parameters
- Comparison of parameters from different controls
- Importing of service files: easy testing of machine parameters in the field
- Rule-based creation and management of machine configurations for multiple controls (together with PLCdesign)

DriveDiag

DriveDiag permits quick and easy troubleshooting of the drive systems. The following diagnostic functions are available:

- Reading and displaying the electronic ID labels of QSY motors with EQN 13xx or ECN 13xx as well as the inverter modules UVR 1xxD and UM 1xxD
- Displaying and evaluating the internal control conditions and the status signals of the inverter components
- Displaying the analog values available to the drive controller
- Automatic test for the proper functioning of motors and inverters, as well as of position and speed encoders

DriveDiag can be called immediately at the control through the diagnostics soft key. End users have read-access, whereas the code number for the machine tool builder gives access to comprehensive testing possibilities with DriveDiag.

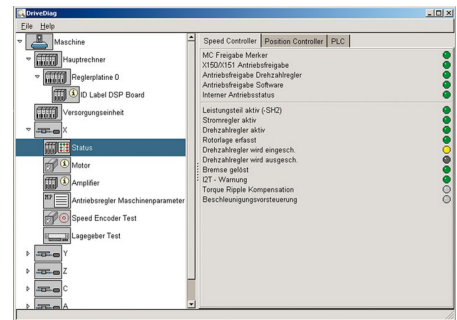

Oscilloscope

The TNC 640 features an integrated oscilloscope. Both X/t and XY graphs are possible. The following characteristic curves can be recorded and stored in six channels:

- Actual value and nominal value of the axis feed rate
- Contouring feed rate
- Nominal and actual position
- Following error of the position controller
- Nominal and actual values for speed, acceleration, and jerk
- Content of PLC operands
- Encoder signal (0°–A) and (90°–B)
- Difference between position and speed encoder
- Nominal velocity value
- Integral-action component of the nominal current value
- Torque-determining nominal current value

Logic signals

Simultaneous graphical representation of the logic states of up to 16 operands (markers, words, inputs, outputs, counters, timers)

- Marker (M)
- Input (I)
- Output (O)
- Timer (T)
- Counter (C)
- IpoLogic (X)

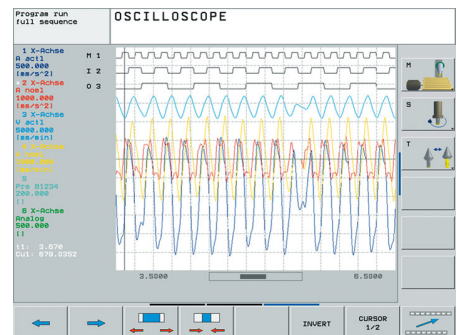

**TNCopt
(accessory)**

PC software for commissioning digital control loops.

Functions (among others):

- Commissioning the current controller
- (Automatic) commissioning the velocity controller
- (Automatic) optimization of sliding-friction compensation
- (Automatic) optimization of compensation for reversal spikes
- (Automatic) optimization of the k_v factor
- Circular interpolation test, contour test

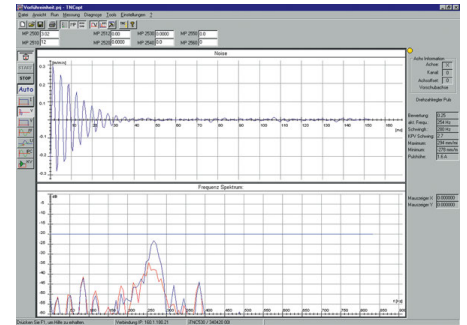

**Online Monitor
(OLM)**

The online monitor is a component of the TNC 640 and is called with a code number. It supports commissioning and diagnosis of control components through the following:

- Display of control-internal variables for axes and channels
- Display of controller-internal variables (if a CC is present)
- Display of hardware signal states
- Various trace functions
- Activation of spindle commands
- Enabling of control-internal debug outputs

**TNCscope
(accessory)**

PC software for transferring the oscilloscope files to a PC. With TNCscope you can record and save up to 16 channels simultaneously.

Note: The trace files are saved in the TNCscope data format.

API DATA

With the API DATA function, the control displays the states or contents of the symbolic API markers and API double words.

Table function

The current conditions of the markers, words, inputs, outputs, counters, and timers are displayed in tables. The conditions can be changed through the keyboard.

Trace function

The current content of the operands and the accumulators is shown in the statement list in each line in hexadecimal or decimal code. The active lines of the statement list are marked.

Log

For the purpose of error diagnostics, all error messages and keystrokes are recorded in a log. The entries can be read using the **PLCdesign** or **TNCremo** software for PCs.

TeleService (accessory)	<p>PC software for remote diagnostics, remote monitoring, and remote operation of the control. For more information, please ask for the <i>Remote Diagnosis with TeleService</i> Technical Information sheet.</p> <table border="0" style="margin-left: 20px;"> <tr> <td>Single station license</td> <td></td> <td>ID 340449-xx</td> </tr> <tr> <td>Network license</td> <td>For 14 workstations</td> <td>ID 340454-xx</td> </tr> <tr> <td></td> <td>For 20 workstations</td> <td>ID 340455-xx</td> </tr> </table>	Single station license		ID 340449-xx	Network license	For 14 workstations	ID 340454-xx		For 20 workstations	ID 340455-xx
Single station license		ID 340449-xx								
Network license	For 14 workstations	ID 340454-xx								
	For 20 workstations	ID 340455-xx								
Bus diagnosis	<p>In Diagnosis mode, the structure of the connected bus systems as well as the details of the connected components can be displayed in a clearly laid out screen.</p>									
State Reporting (software option 137)	<p>With the State Reporting Interface (SRI) software option, HEIDENHAIN offers an interface for the simple provision of machine operating states for a higher-level machine data or production data acquisition system (MDA/PDA).</p>									
TNCtest	<p>Acceptance tests on machine tools with external or integrated functional safety (FS) must be conducted reproducibly and verifiably.</p> <p>The TNCtest and TestDesign program package can be used to plan and perform acceptance tests for machine tools with HEIDENHAIN controls. The acceptance tests are planned with TestDesign and run with TNCtest.</p> <p>The TNCtest programs are designed to provide support during acceptance testing, provide required information, and perform automatic configurations, as well as record data and evaluate the data semiautomatically. A tester must evaluate manually whether a test case passed or failed.</p>									
TNCAnalyzer	<p>The TNCAnalyzer application from HEIDENHAIN provides for simple and intuitive evaluation of service files and log files.</p> <p>Function:</p> <ul style="list-style-type: none"> • Loading of service and log files • Analysis of temporal sequences and static states • Filters and search functions • Data export (HELogger, CSV, and JSON formats) • Definition of application-specific analysis profiles • Preconfigured analysis profiles • Graphical display of signals via TNCscope • Interaction with other tools that are intended for the display of special sections of the service file 									

Integrated PLC

Overview

The PLC program is created by the machine manufacturer either at the control or with the PLC development software **PLCdesign** (accessory). Machine-specific functions are activated and monitored via the PLC inputs/outputs. The number of PLC inputs/outputs required depends on the complexity of the machine.

PLC inputs/outputs

PLC inputs and outputs are available via the external PL 6000 PLC input/output systems or the UEC 11x. The PLC inputs/outputs and the PROFINET IO or PROFIBUS DP-capable I/O system must be configured with the IOconfig PC software.

PLC programming

Format	Statement list
Memory	Min. 1 GB
Cycle time	9 ms to 30 ms (adjustable)
Command set	<ul style="list-style-type: none">• Bit, byte, and word commands• Logical operations• Arithmetic commands• Comparisons• Bracketed terms• Jump commands• Subprograms• Stack operations• Submit programs• Timers• Counters• Comments• PLC modules• Strings

Encryption of PLC data

The encrypted PLC partition (PLCE:) provides the machine tool builder with a tool for preventing third parties from viewing or changing files. The files on the PLCE partition can be read only by the control itself or by using the correct OEM keyword. This ensures that proprietary know-how and special customer-specific solutions cannot be copied or changed.

The machine manufacturer can also determine the size of the encrypted partition. This is not determined until the machine manufacturer creates the PLCE partition. Another advantage is that, in spite of the encryption, the data can be backed up from the control to a separate data medium (USB drive, network, e.g., through TNCremo) and later restored. You need not enter the password, but the data cannot be read until the keyword is supplied.

PLC window The TNC 640 can display PLC error messages in the dialog line during operation.

Small PLC window The TNC 640 can show additional PLC messages and bar diagrams in the small PLC window.

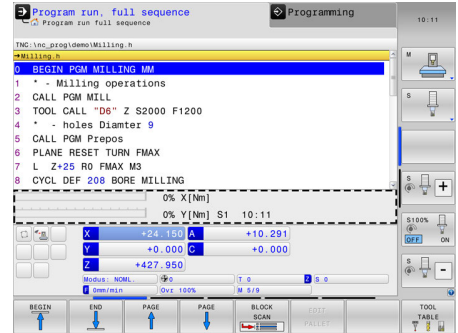

PLC soft keys The machine manufacturer can display his own PLC soft keys in the vertical soft-key row on the screen.

PLC positioning All closed-loop axes can also be positioned via the PLC. PLC positioning of the NC axes cannot be superimposed on NC positioning.

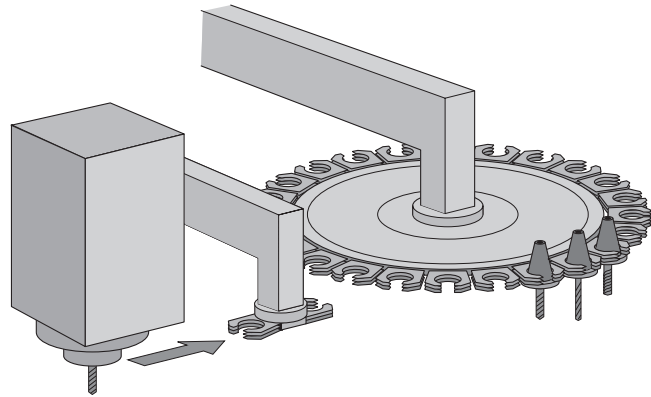

PLC axes Axes can be defined as PLC axes. They are programmed by means of M functions or OEM cycles. The PLC axes are positioned independently of the NC axes.

PLCdesign (accessory) PC software for PLC program development. The PC program **PLCdesign** can be used for easy creation of PLC programs. Extensive examples of PLC programs are included with the product.

Functions:

- Easy-to-use text editor
- Menu-guided operation
- Programming of symbolic operands
- Modular programming techniques
- "Compiling" and "linking" of PLC source files
- Operand commenting, creation of the documentation file
- Comprehensive help system
- Data transfer between the PC and control
- Creation of PLC soft keys

Python OEM Process (software option 46)

The Python OEM Process software option gives the machine manufacturer a powerful tool for using a high-level, object-oriented programming language in the control (PLC). Python is an easy-to-learn script language supporting all necessary high-level language elements.

Python OEM Process can be used universally for machine functions and complex calculations, as well as to display special user interfaces. User-specific or machine-specific solutions can be efficiently implemented. Numerous libraries on the basis of Python and GTK are available, regardless of whether you want to create special algorithms for special functions, or separate solutions such as an interface for machine maintenance software.

The applications you create can be included via the PLC in the familiar PLC windows, or they can be displayed in separate free windows that can be expanded to the control's full screen size.

Simple Python scripts (e.g., for display masks) can also be executed without enabling the Python OEM Process software option (software option 46). Ten megabytes of dedicated memory are reserved for this function. For more information, refer to the *Python in HEIDENHAIN Controls Technical Manual*.

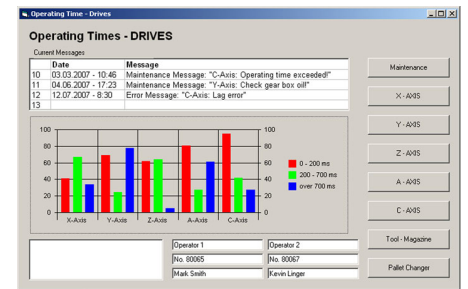

PLC basic program

The PLC basic program serves as a basis for adapting the control to the requirements of the respective machine. It can be downloaded from the Internet.

These essential functions are covered by the PLC basic program:

Axes

- Control of analog and digital axes
- Axes with clamping mode
- Axes with central drive
- Axes with Hirth grid
- Synchronized axes
- 3-D head with C-axis mode
- Reference run, reference end position
- Axis lubrication

Spindles

- Control and orientation of the spindles
- Spindle clamping
- Alternative double-spindle operation
- Parallel spindle operation
- Conventional 2-stage gear system
- Wye/delta connection switchover (static, dynamic)

Tool changers

- Manual tool changer
- Tool changer with pick-up system
- Tool changer with dual gripper
- Tool changer with positively driven gripper
- Rotating tool magazine with closed-loop axis
- Rotating tool magazine with controlled axis
- Servicing functions for the tool changer
- Python tool management

Pallet changers

- Translational pallet changer
- Rotatory pallet changer
- Servicing functions for the pallet changer

Safety functions

- Emergency stop test (EN 13849-1)
- Brake test (EN 13849-1)
- Repeated switch-on test for a wireless handwheel

General functions

- Feed rate control
- Control of the coolant system (internal, external, air)
- Toggling between milling and turning modes
- Temperature compensation
- Activate tool-specific torque monitoring
- Hydraulic control
- Chip conveyor
- Indexing fixture
- Touch probes
- PLC support for handwheels
- Control of doors
- Handling of M functions
- PLC log
- Display and management of PLC error messages
- Diagnostics screen (Python)
- Python example applications
- Status display in the small PLC window

Interfacing to the machine

- OEM cycles** The machine tool builder can create and store his own cycles for recurring machining tasks. These OEM cycles are used in the same way as standard HEIDENHAIN cycles.
- CycleDesign (accessory)** The soft-key structure for the cycles is managed using the **CycleDesign** PC program. In addition, CycleDesign can be used to store help graphics and soft keys in BMP format in the TNC. Graphic files can be compressed to ZIP format to reduce the amount of memory used.
- Tool Management** With integral PLC, the tool changer is moved either via proximity switch or as a controlled axis. Complete tool management with tool life monitoring and replacement tool monitoring is carried out by the TNC 640.
- Tool Calibration** Tool touch probes can be measured and checked with the **TT** tool touch probe system (accessory). Standard cycles for automatic tool measurement are available in the control. The control calculates the probing feed rate and the optimal spindle speed. The measured data are stored in a tool table.



- Touch-Probe Configuration** All touch-probe data can be configured conveniently through a table. All HEIDENHAIN touch probe systems are preconfigured and can be selected through a drop-down menu.

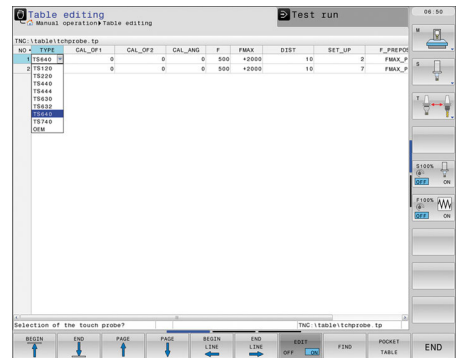

- Pallet Management** Pallet feeding can be controlled via PLC axes. The user defines the pallet sequence, pallet presets, and workpiece presets in the pallet tables. The pallet tables are freely configurable; any information can be stored in the tables and called via the PLC. Pallet table execution can be workpiece- or tool-oriented.

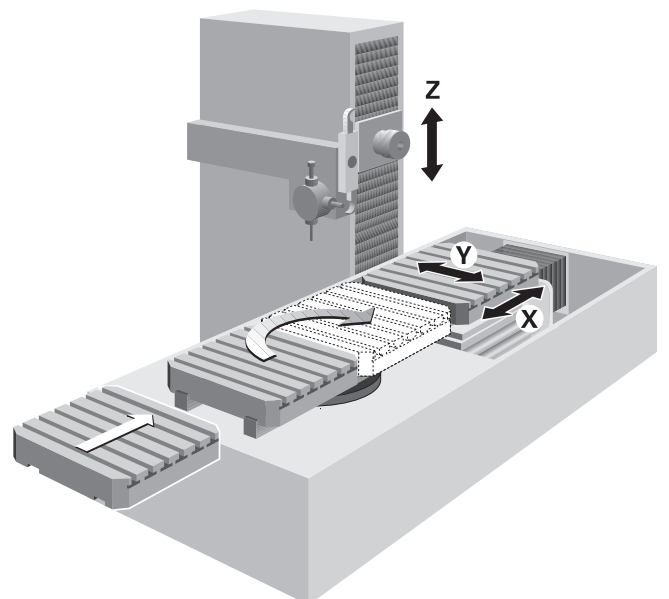

Data transfer and communication

Data interfaces

Overview	The TNC 640 is connected to PCs, networks, and other data storage devices via data interfaces.
Ethernet	<p>The TNC 640 can be interconnected via the Ethernet interface. For connection to the data network, the control features a 1000BASE-T (twisted pair Ethernet) connection.</p> <p>Maximum transmission distance: Unshielded: 100 m Shielded: 400 m</p>
Protocol	The TNC 640 communicates using the TCP/IP protocol.
Network connection	<ul style="list-style-type: none">• NFS file server• Windows networks (SMB)
Data transmission speed	Approx. 400 to 800 Mbit/s (depending on the file type and network utilization)
V.24/RS-232-C for the MC 8xxx and MC 6xxx	Data interface according to DIN 66020 or EIA standard RS-232-C. Maximum transmission distance: 20 m
Data transmission speed	115 200; 57 600; 38 400; 19 200; 9600; 4800; 2400; 1200; 600; 300; 150; 110 bps
Protocols	The TNC 640 can transfer data using various protocols.
Standard data transmission	The data is transferred character by character. The number of data bits, stop bits, the handshake, and character parity must be set by the user.
Blockwise data transfer	The data is transferred blockwise. A block check character (BCC) is used for data backup. This method improves data security.
LSV2	Bidirectional transfer of commands and data as per DIN 66019. The data is divided into telegrams (blocks) and transmitted.
USB	The TNC 640 features USB interfaces for the connection of standard USB devices such as a mouse, hard drive, etc. On the back of the MC 8xxx and MC 6xxx are four USB 3.0 ports. One of them leads to the TE, where a cover cap protects it from contamination. More USB 2.0 ports are in the integrated USB hub on the rear of the BF. The USB ports are rated for a maximum of 0.5 A.
USB cables	Cable length of up to 5 m ID 354770-xx Cable length of 6 m to 30 m with integrated amplifier; limited to USB 1.1. ID 624775-xx

Software for data transfer

We recommend using HEIDENHAIN software to transfer files between the TNC 640 and a PC.

TNCremo (accessory)

This PC software package supports the user in transmitting data from the PC to the control. This software implements blockwise data transfer with block check characters (BCC).

Functions:

- Data transfer (including blockwise)
- Remote control (only serial)
- File management and data backup of the control
- Reading out the log
- Print-out of screen contents
- Text editor
- Managing more than one machine

TNCremoPlus (accessory)

In addition to the features already familiar from TNCremo, TNCremoPlus can also transfer the current content of the control's screen to the PC (live screen). This makes it very simple to monitor the machine.

Additional functions:

- Interrogation of control information (NC uptime, machine uptime, machine running time, spindle running time, pending errors, data from the data servers—e.g., symbolic PLC operands)
- Targeted overwriting of tool data using the values of a tool presetter

TNCremoPlus

ID 340447-xx

Connected Machining

Overview

Connected Machining makes uniformly digital job management possible in networked manufacturing. You also profit from:

- Easy data usage
- Time-saving procedures
- Transparent processes

Remote Desktop Manager (software option 133)

Remote control and display of external computers over an Ethernet connection (e.g., Windows PC). The information is displayed on the control's screen. Remote Desktop Manager allows you to access important applications, such as CAD/CAM applications or order management, from the control.

Remote Desktop Manager ID 894423-xx

HEIDENHAIN DNC (software option 18)

The development environments on Windows operating systems are particularly well suited as flexible platforms for application development in order to handle the increasingly complex requirements of the machine's environment.

The flexibility of the PC software and the large selection of ready-to-use software components and standard tools in the development environment enable you to develop PC applications of great use to your customers in a very short time, for example:

- Error reporting systems that, for example, send the customer a text message to his cell phone reporting problems on the currently running machining process
- Standard or customer-specific PC software that decidedly increases process reliability and equipment availability
- Software solutions controlling the processes of manufacturing systems
- Information exchange with job management software

The HEIDENHAIN DNC software interface is an attractive communication platform for this purpose. It provides all the data and configuration capabilities needed for these processes so that an external PC application can evaluate data from the control and, if required, influence the manufacturing process.

RemoTools SDK (accessory)

To enable you to use HEIDENHAIN DNC effectively, HEIDENHAIN offers the RemoTools SDK development package. It contains the COM component and the ActiveX control for integration of the DNC functions in development environments.

RemoTools SDK ID 340442-xx

For more information, refer to the *HEIDENHAIN DNC* brochure.

virtualTNC (accessory)

The **virtualTNC** control software is a control component for virtual machines for machine simulations, and is available via the HEIDENHAIN DNC interface.

Single station license ID 1113933-02

Network license For one work station ID 1122145-02

For 14 workstations ID 1113935-02

For 20 workstations ID 1113936-02

For more information, refer to the *HEIDENHAIN DNC* brochure.

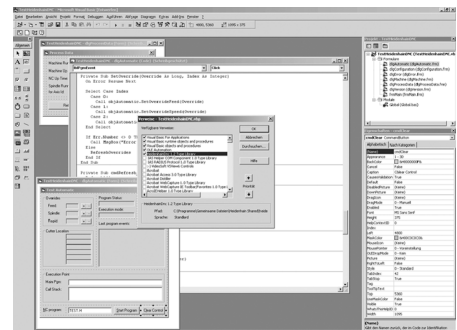
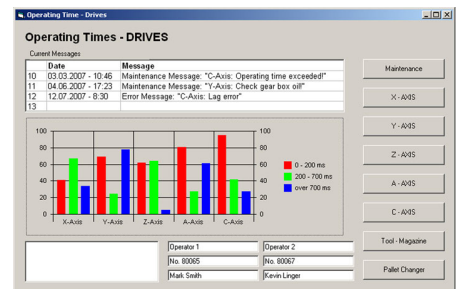

**OPC UA NC
Server
(software
option 56-61)**

The Open Platform Communications Unified Architecture (OPC UA) standard has emerged in recent years as a well-established interface for secure and reliable data exchange in industrial environments. The new HEIDENHAIN OPC UA NC Server software option makes this forward-looking interface available on the TNC 640. OPC UA features cross-operating system capability: along with the widespread Windows systems, OPC UA also allows Linux-based systems or Apple Computers with macOS*, for example, to be connected to the HEIDENHAIN control.

Numerous developer toolkits are available for OPC UA. RemoTools SDK is not needed. Thanks to the standardized protocol, the freedom to choose the toolkit, and the application-oriented HEIDENHAIN information model, highly individualized applications and standard software can be developed with significantly reduced time to market.

The HEIDENHAIN OPC UA NC Server supports the following OPC UA services:

- Reading and writing variables
- Subscribing to value changes
- Executing methods
- Subscribing to events

With Sign&Encrypt, HEIDENHAIN ensures that even the standard solution provides state-of-the-art IT security:

- SecurityMode: Sign&Encrypt
- Cryptographic algorithm: Basic256Sha256 (recommendation of OPC Foundation) – X.509 Certificates
- User authentication through X.509 certificates

* Apple and macOS are trademarks of Apple Inc.

Mounting information

Clearances and mounting

Proper minimum clearance

When mounting the control components, please observe proper minimum clearances and space requirements, as well as the length and position of the connecting cables.

Installation in an electrical cabinet

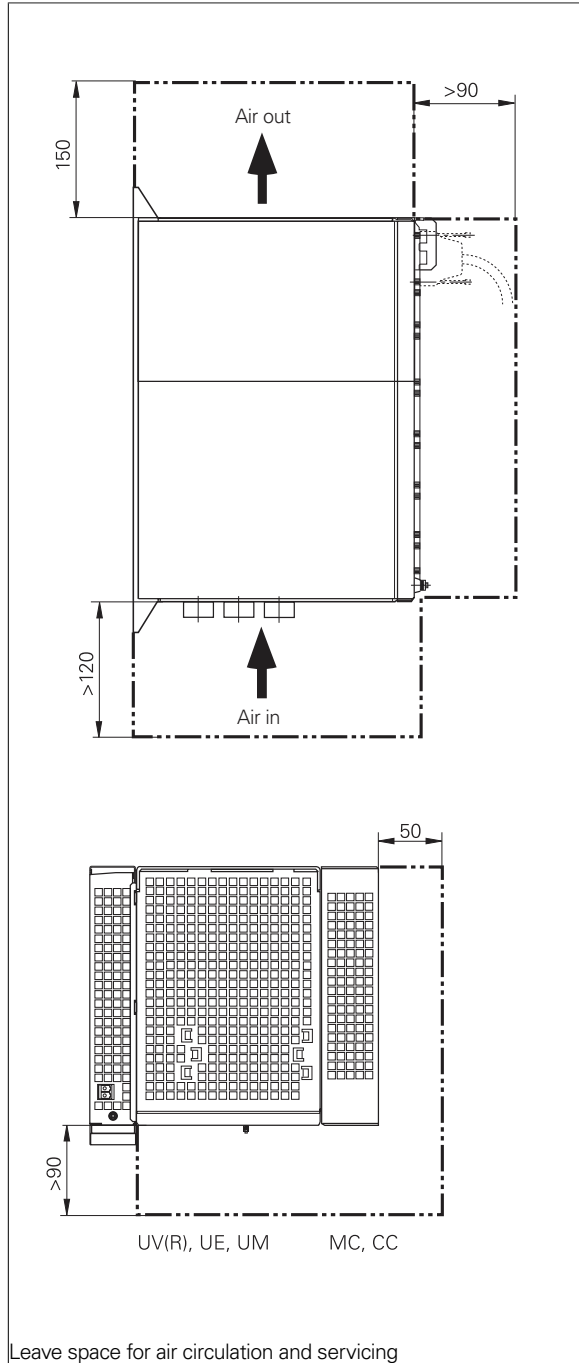

Installation in an operating panel

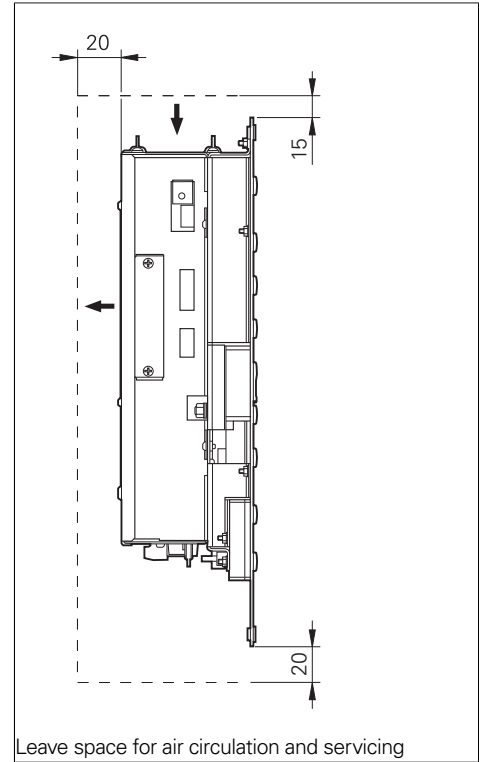

Mounting and electrical installation

- Observe the following points during mounting and electrical connection:
- National regulations for low-voltage installations at the operating site of the machine or components
 - National regulations regarding interference and noise immunity at the operating site of the machine or components
 - National regulations regarding electrical safety and operating conditions at the operating site of the machine or components
 - Specifications for the installation position
 - Specifications of the Technical Manual

Degrees of protection

- The following components fulfill the requirements for IP54 (dust protection and splash-proof protection):
- Display unit (when properly installed)
 - Keyboard unit (when properly installed)
 - Machine operating panel (when properly installed)
 - Handwheel

All electric and electronic control components must be installed in an environment (e.g., electrical cabinet, housing) with an IP54 rating (dust and splash-proof protection) in order to fulfill the requirements of pollution degree 2. All components of the OEM operating panel must also have an IP54 rating, just like the HEIDENHAIN operating panel components.

Electromagnetic compatibility

Protect your equipment from interference by observing the rules and recommendations specified in the Technical Manual.

Intended place of operation

This unit fulfills the requirements of EN 50370-1 and is intended for operation in industrially zoned areas.

Likely sources of interference

- Interference is produced by capacitive and inductive coupling into electrical conductors or into device connections, caused by, e.g.:
- Strong magnetic fields from transformers or electric motors
 - Relays, contactors, and solenoid valves
 - High-frequency equipment, pulse equipment, and stray magnetic fields from switch-mode power supplies
 - Power lines and leads to the above equipment

Protective measures

- Ensure that the MC, CC, and signal lines are at least 20 cm away from interfering devices
- Ensure that the MC, CC, and signal lines are at least 10 cm away from cables carrying interfering signals. For cables in metallic ducting, adequate decoupling can be achieved by using a grounded separation shield.
- Shielding according to EN 50178
- Use equipotential bonding lines according to the grounding plan. Please refer to the Technical Manual of your control.
- Use only genuine HEIDENHAIN cables and connecting elements

Installation elevation

The maximum altitude for installation of HEIDENHAIN control components (MC, CC, PLB, MB, TE, BF, IPC, etc.) is 3000 m above sea level.

Overall dimensions

Main computer

MC 6541, MC 6641, IPC 6641

mm



Tolerancing ISO 8015

ISO 2768 - m H

< 6 mm: ± 0.2 mm

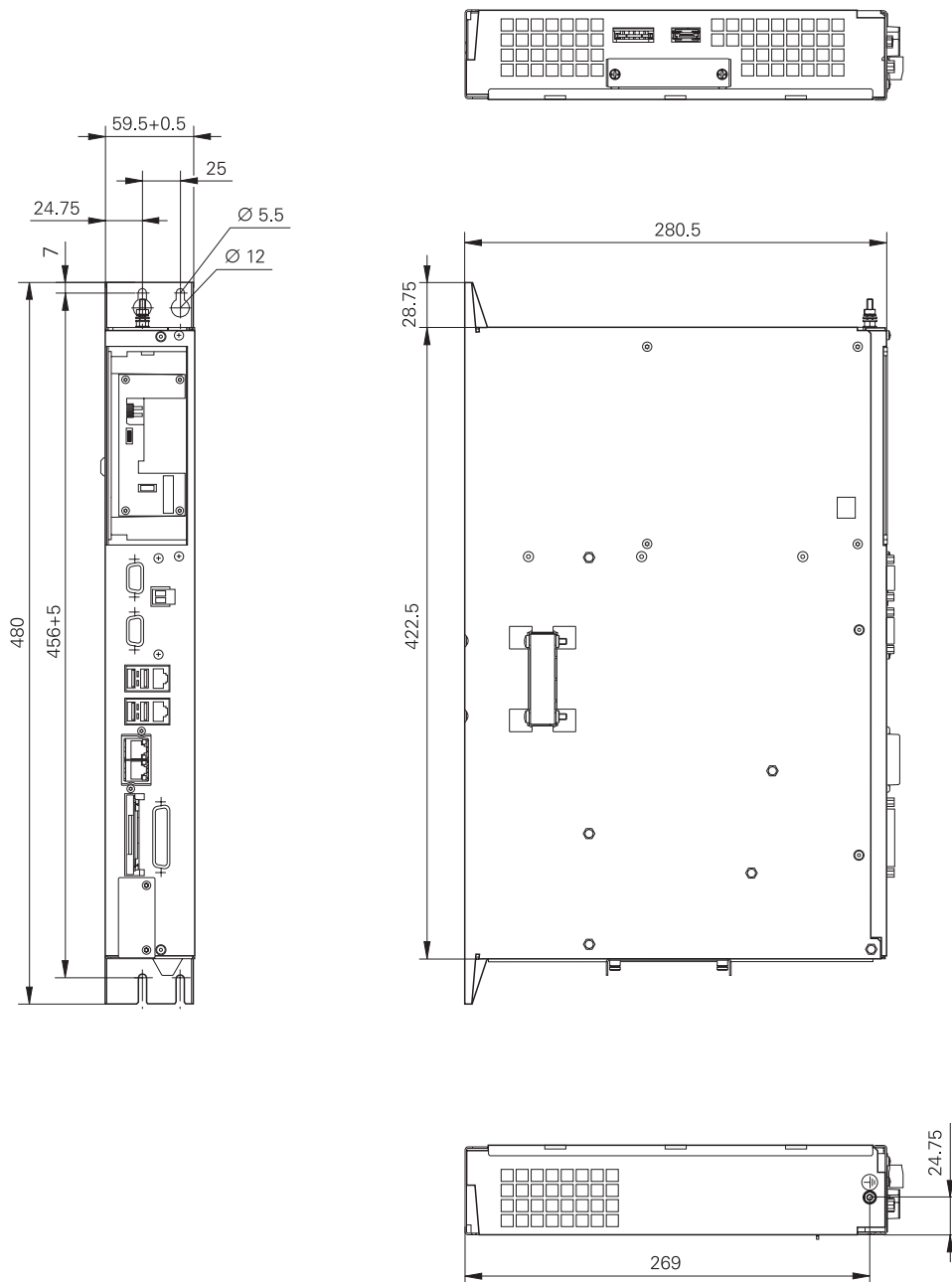

MC 6542, IPC 6490

mm



Tolerancing ISO 8015

ISO 2768 - m H

< 6 mm: ±0.2 mm

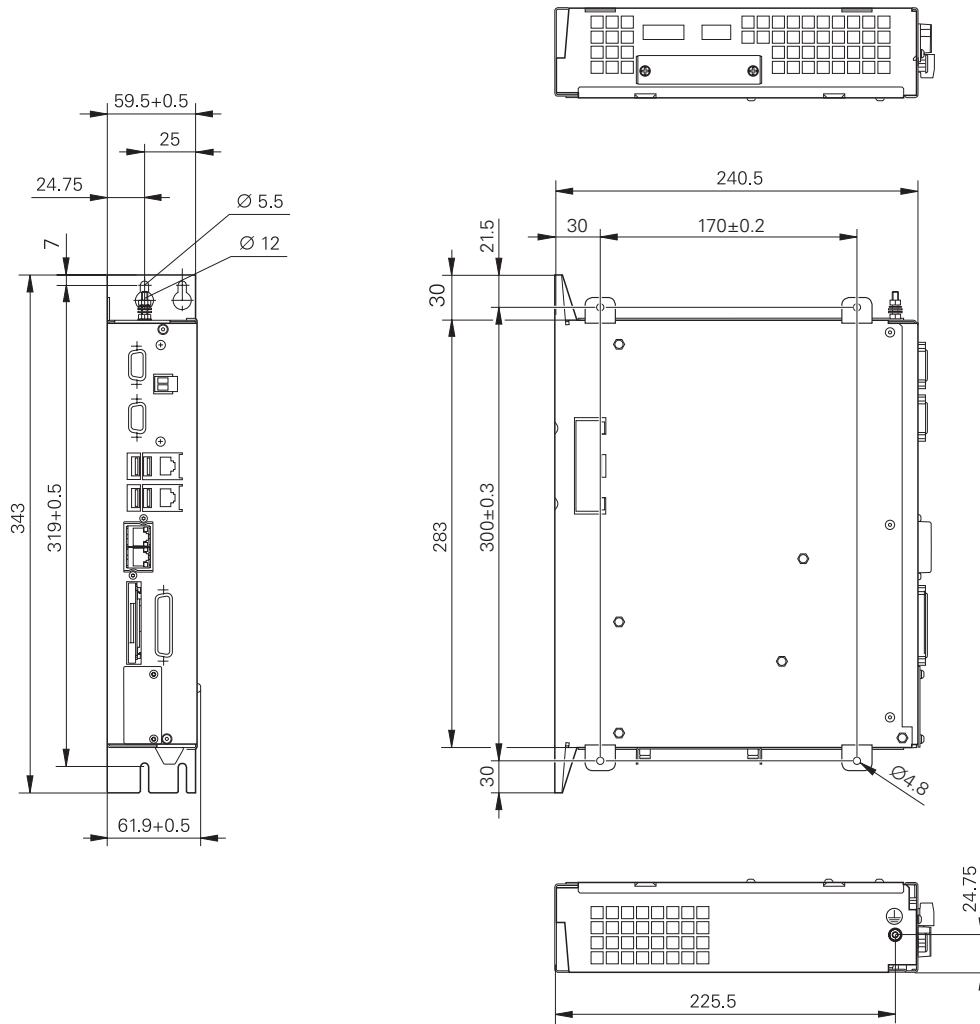

MC 7522

mm

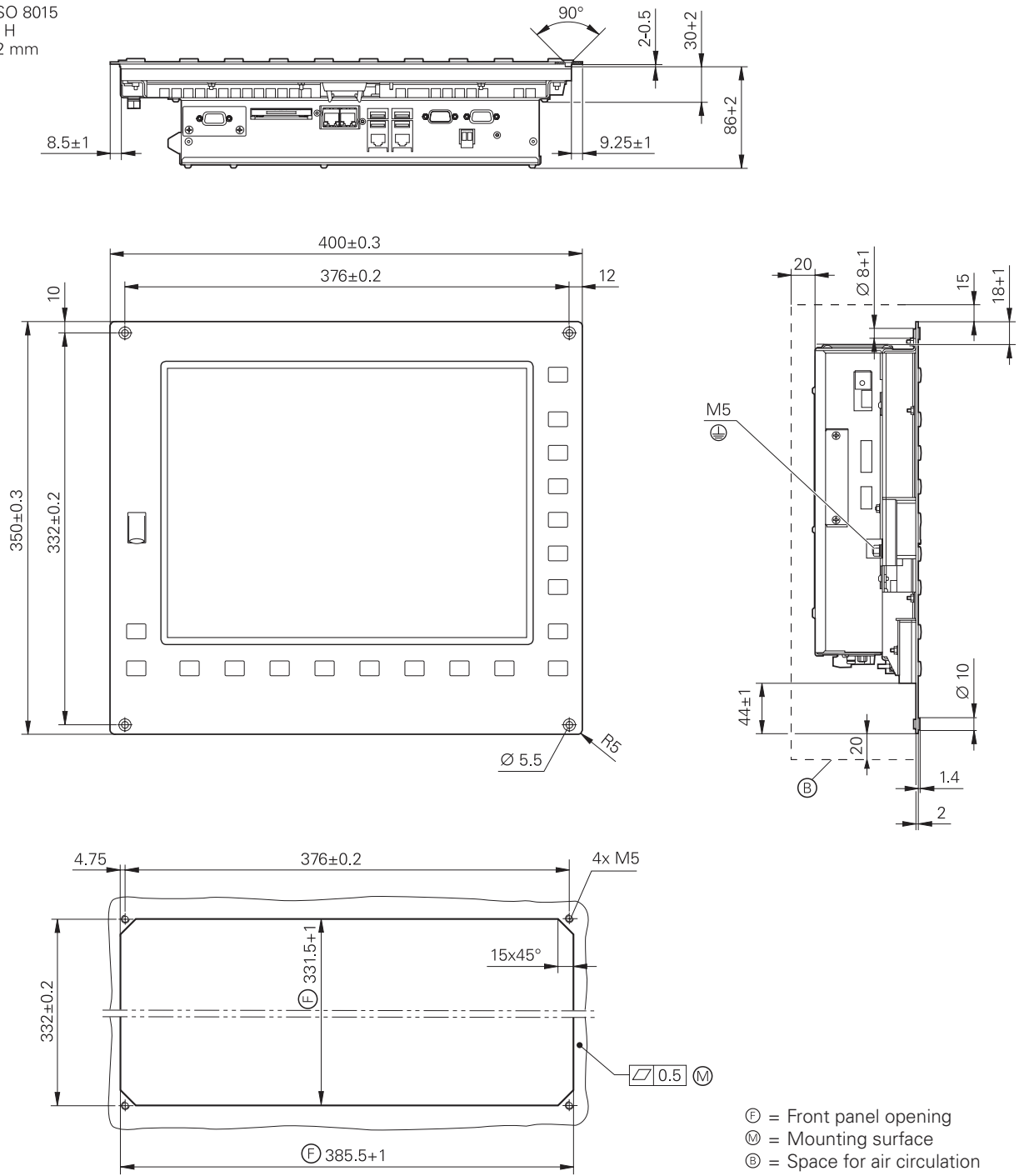
 Tolerancing ISO 8015
 ISO 2768 - m H
 < 6 mm: ±0.2 mm



MC 8512

mm



Tolerancing ISO 8015
ISO 2768 - m H
< 6 mm: ±0.2 mm

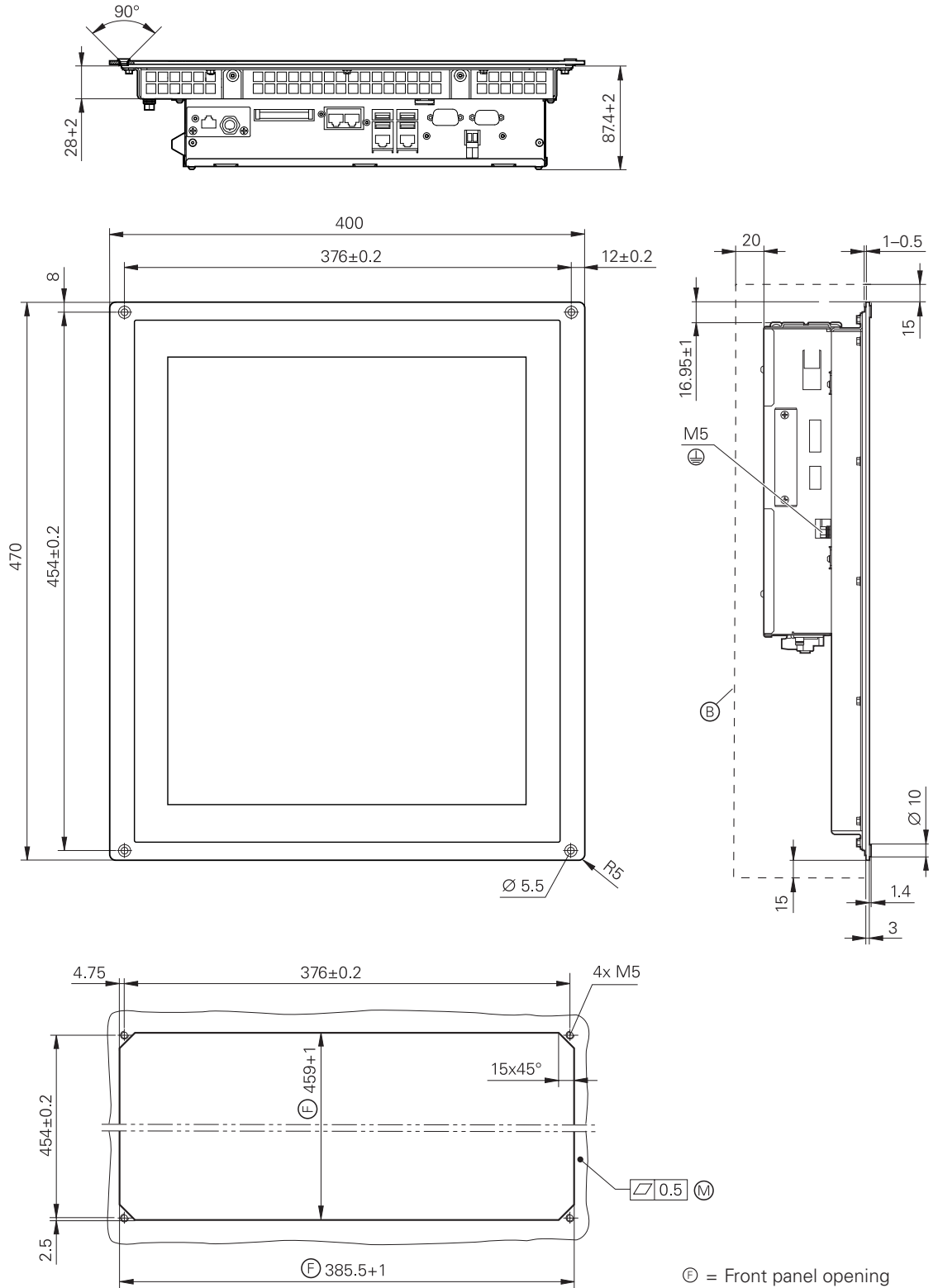

- ⊕ = Front panel opening
- Ⓜ = Mounting surface
- Ⓟ = Space for air circulation

MC 8532

mm

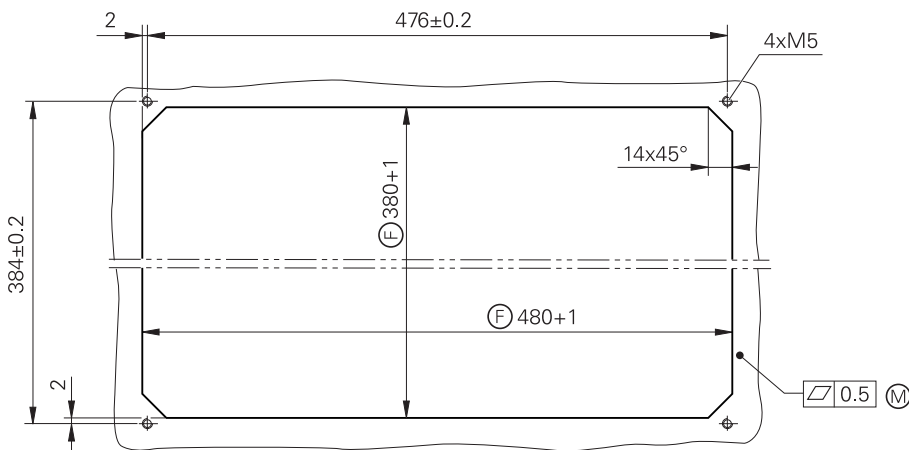
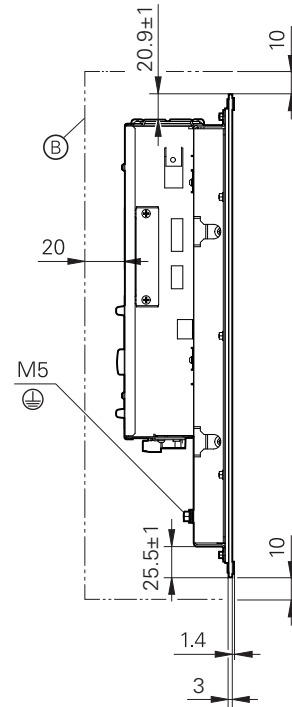
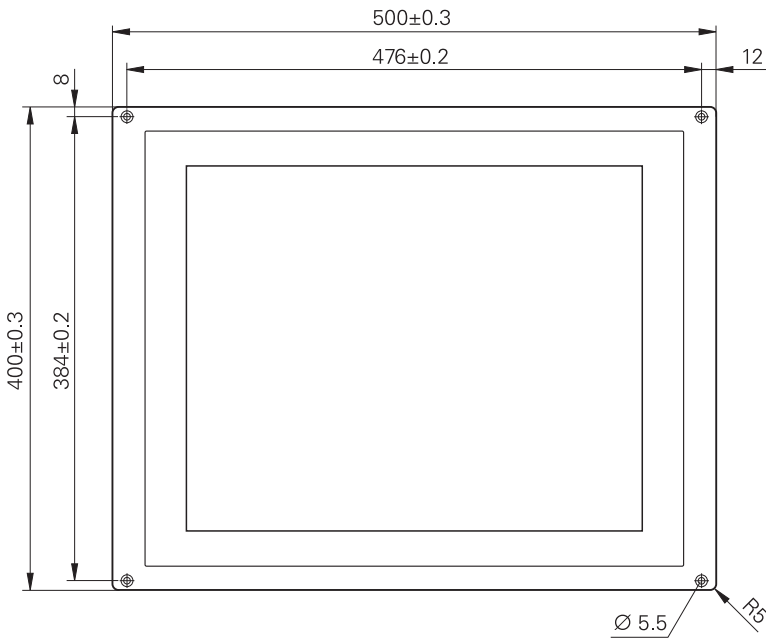
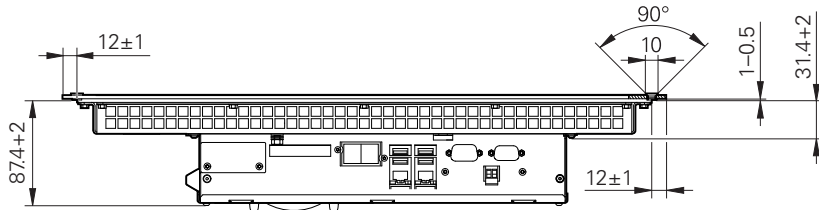
 Tolerancing ISO 8015
 ISO 2768 - m H
 < 6 mm: ±0.2 mm



- ⓕ = Front panel opening
- Ⓜ = Mounting surface
- Ⓟ = Space for air circulation

Controller unit

CC 6106

mm



Tolerancing ISO 8015

ISO 2768 - m H

< 6 mm: ± 0.2 mm

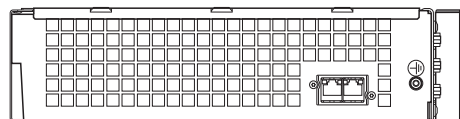
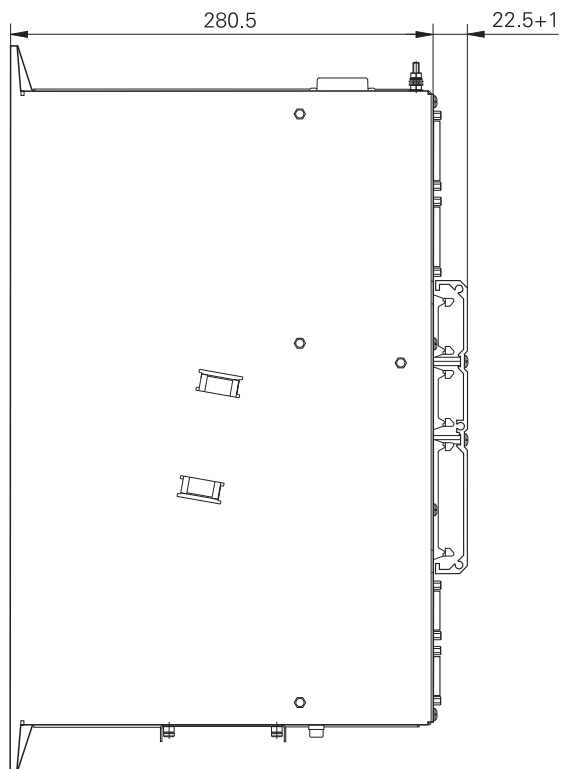
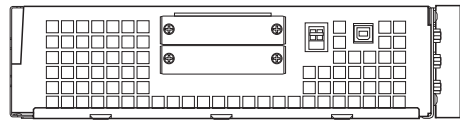
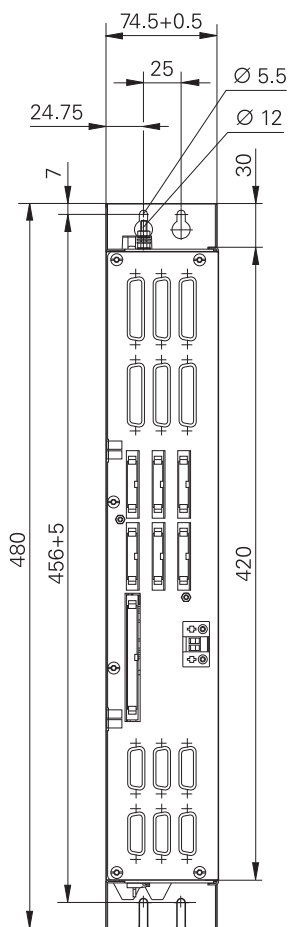

CC 6108, CC 6110

mm
Tolerancing ISO 8015
ISO 2768 - m H
< 6 mm: ±0.2 mm

CC 6108: 8 control loops
CC 6110: 10 control loops

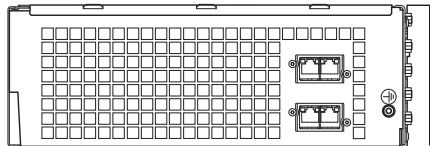
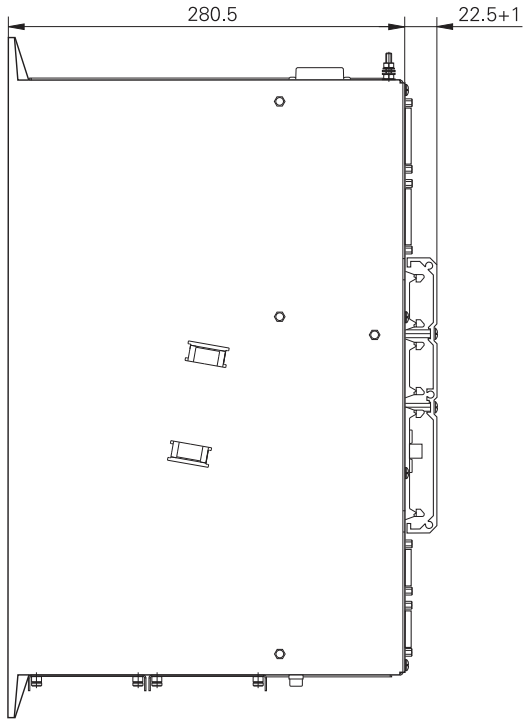
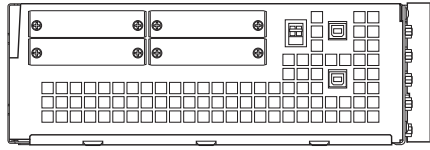
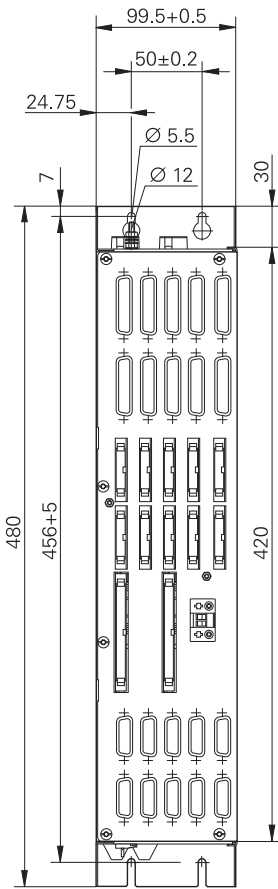

UEC 111, UEC 112, UEC 113

mm



Tolerancing ISO 8015

ISO 2768 - m H

< 6 mm: ±0.2 mm

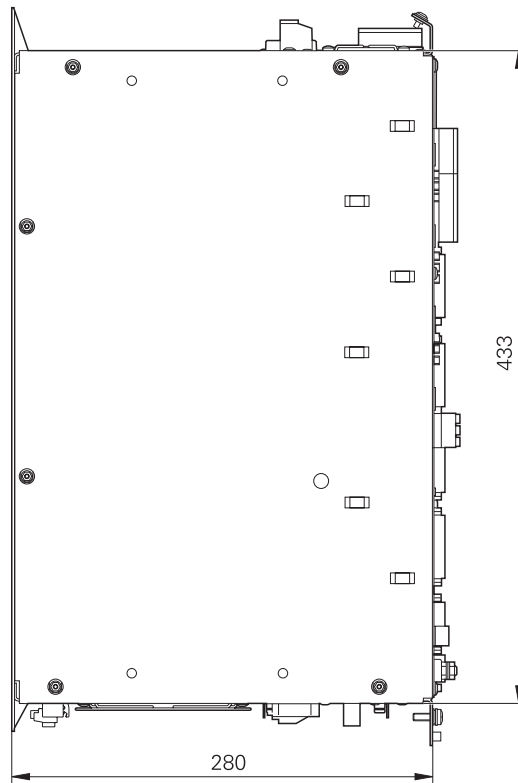
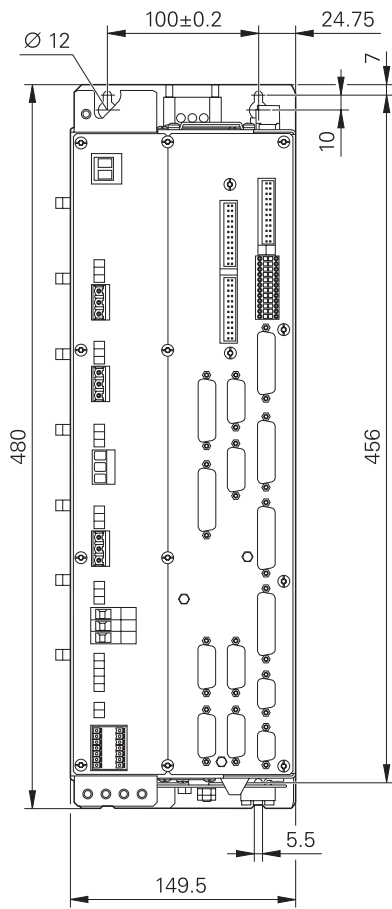

UMC 111 FS

mm
Tolerancing ISO 8015
ISO 2768 - m H
< 6 mm: ±0.2 mm

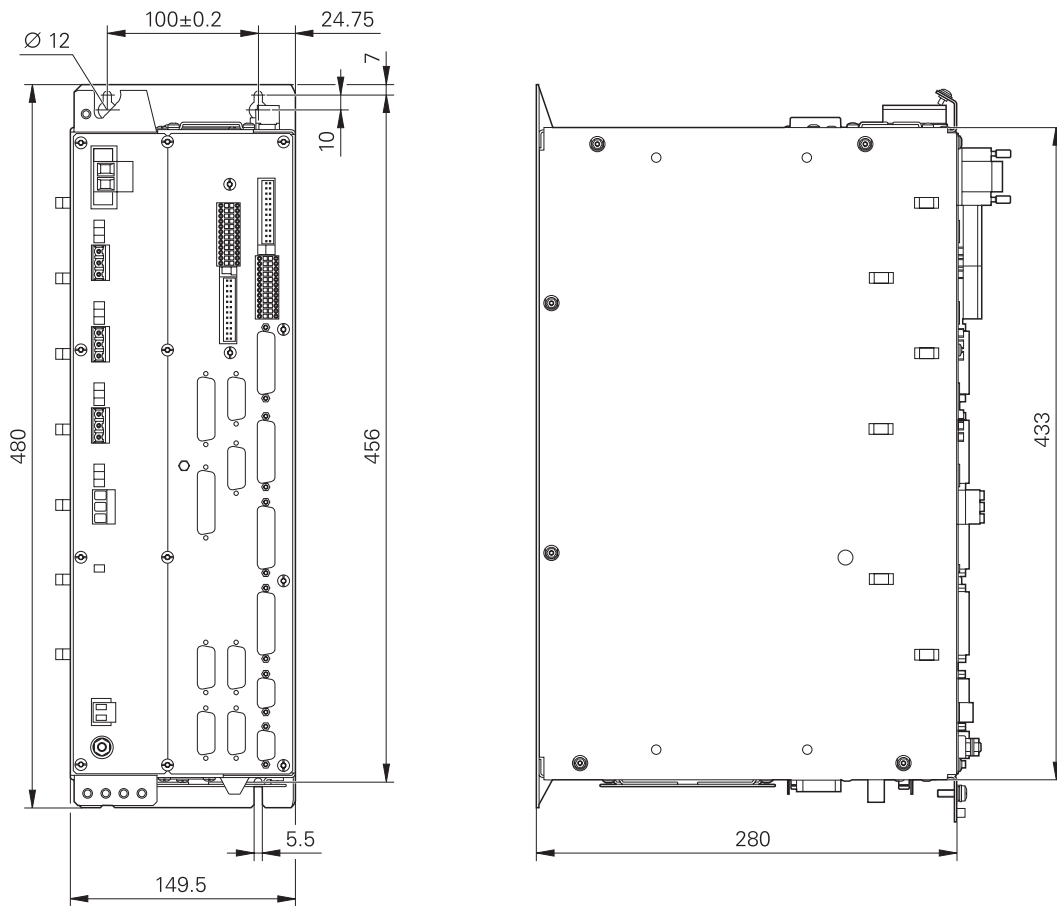

Operating panel, screen, and keyboard

ITC 755

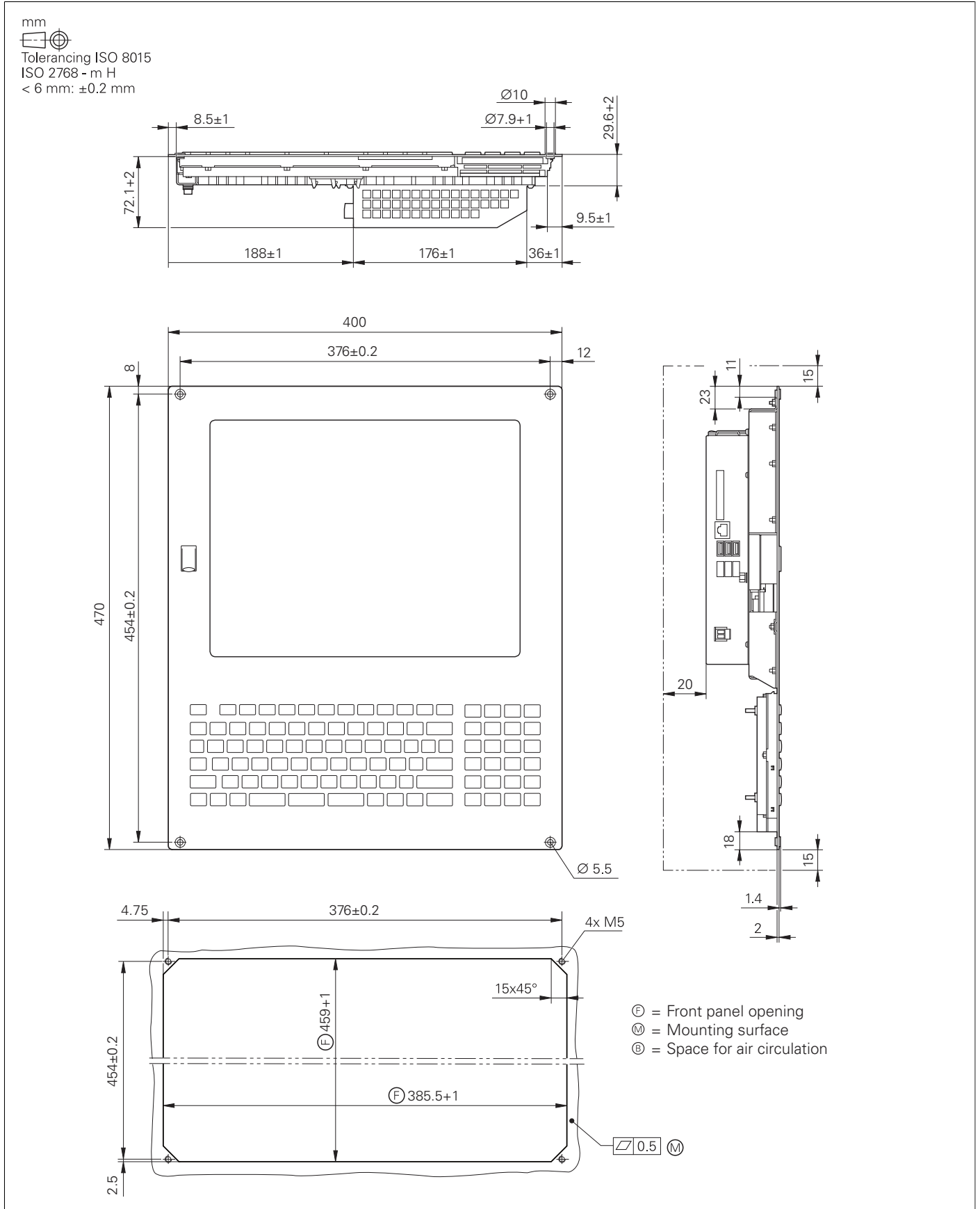

BF 860, ITC 860

mm

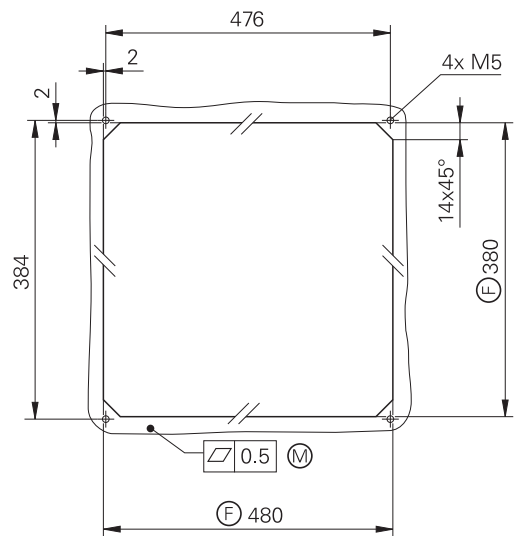
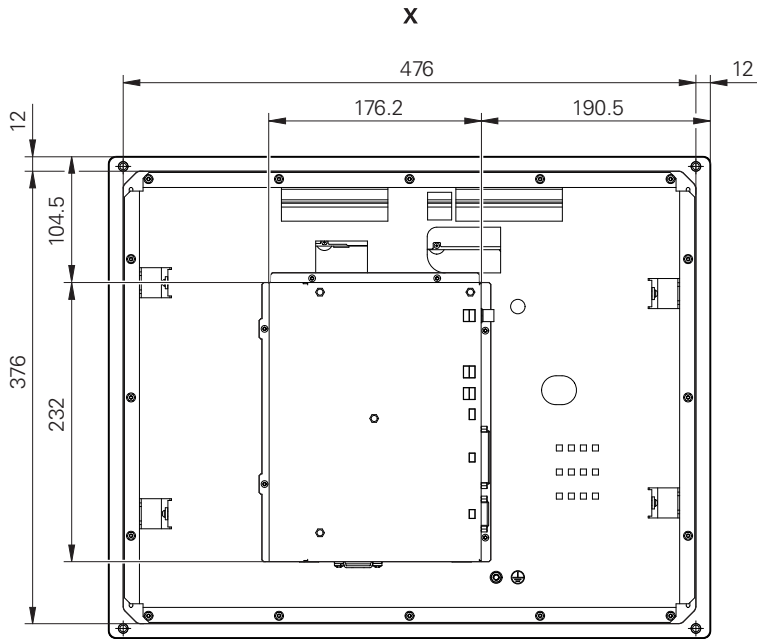
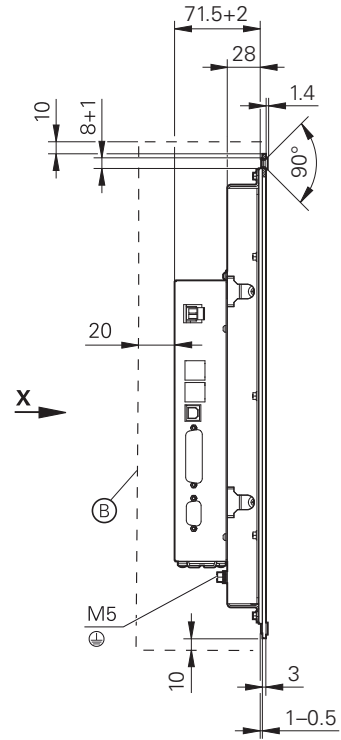
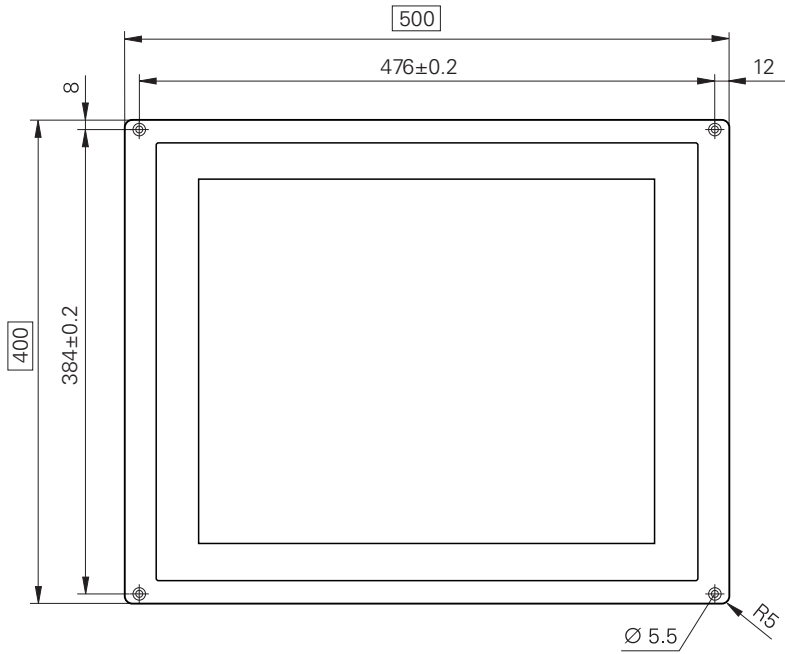
 Tolerancing ISO 8015
 ISO 2768 - m H
 < 6 mm: ±0.2 mm



- Ⓧ = Front panel opening
- Ⓜ = Mounting surface
- Ⓢ = Space for air circulation

TE 745, TE 745 FS

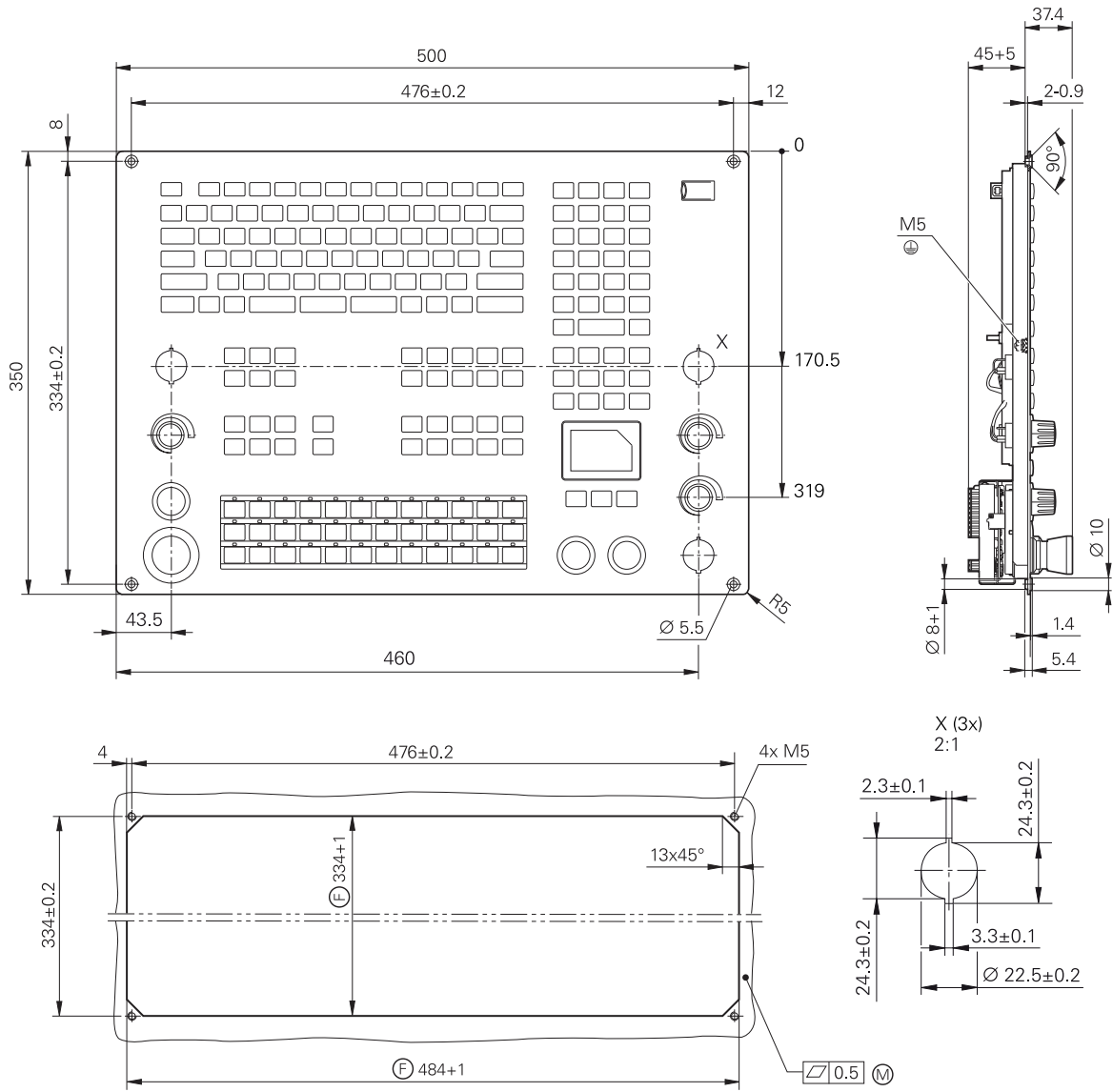
mm

 Tolerancing ISO 8015
 ISO 2768 - m H
 < 6 mm: ±0.2 mm



Ⓧ = Front panel opening
 Ⓜ = Mounting surface

ITC 750

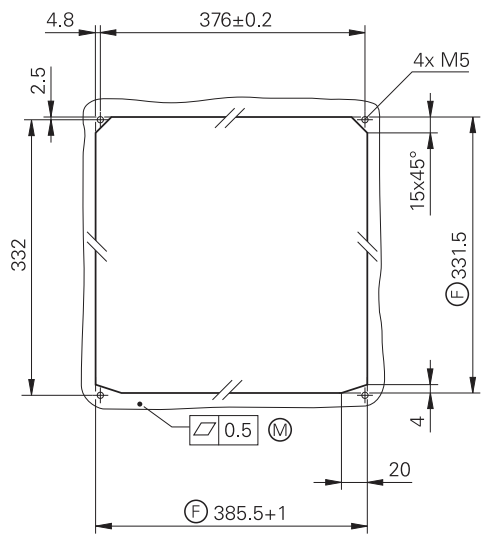
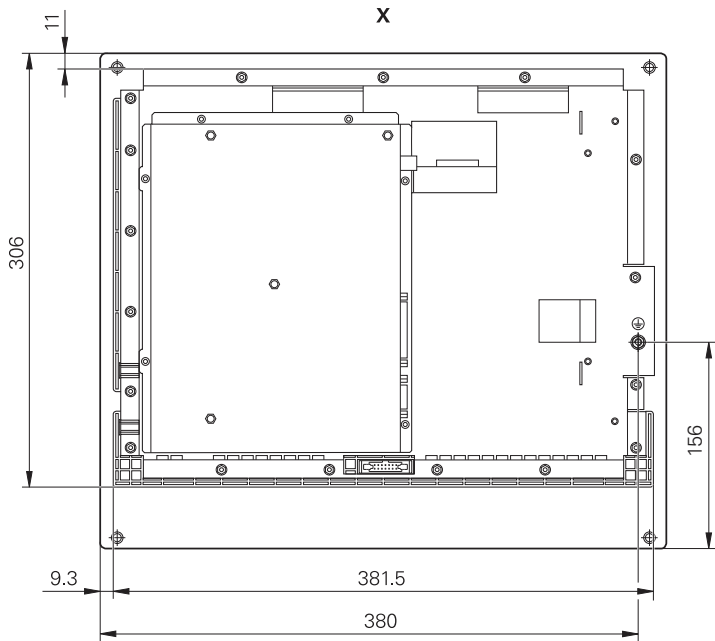
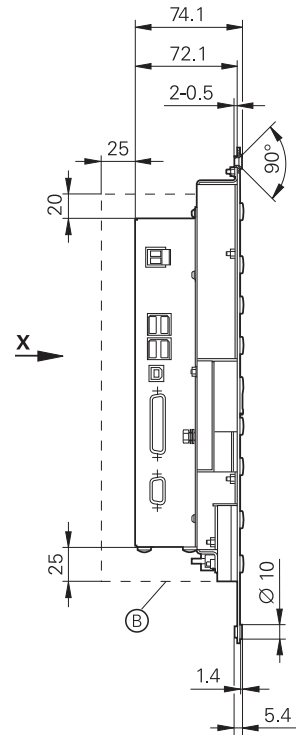
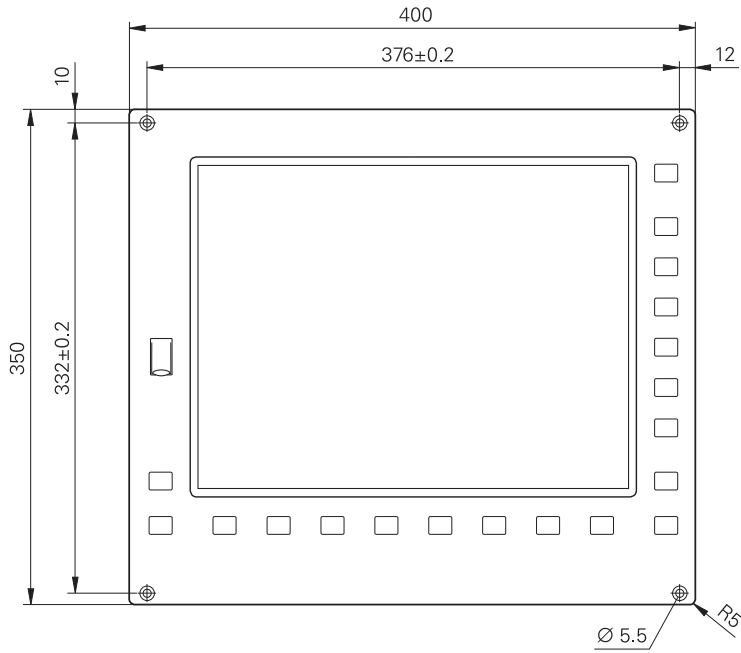
mm

 Tolerancing ISO 8015
 ISO 2768 - m H
 < 6 mm: ±0.2 mm



- ⊕ = Front panel opening
- Ⓜ = Mounting surface
- Ⓟ = Space for air circulation

TE 730

mm



Tolerancing ISO 8015
 ISO 2768 - m H
 < 6 mm: ±0.2 mm

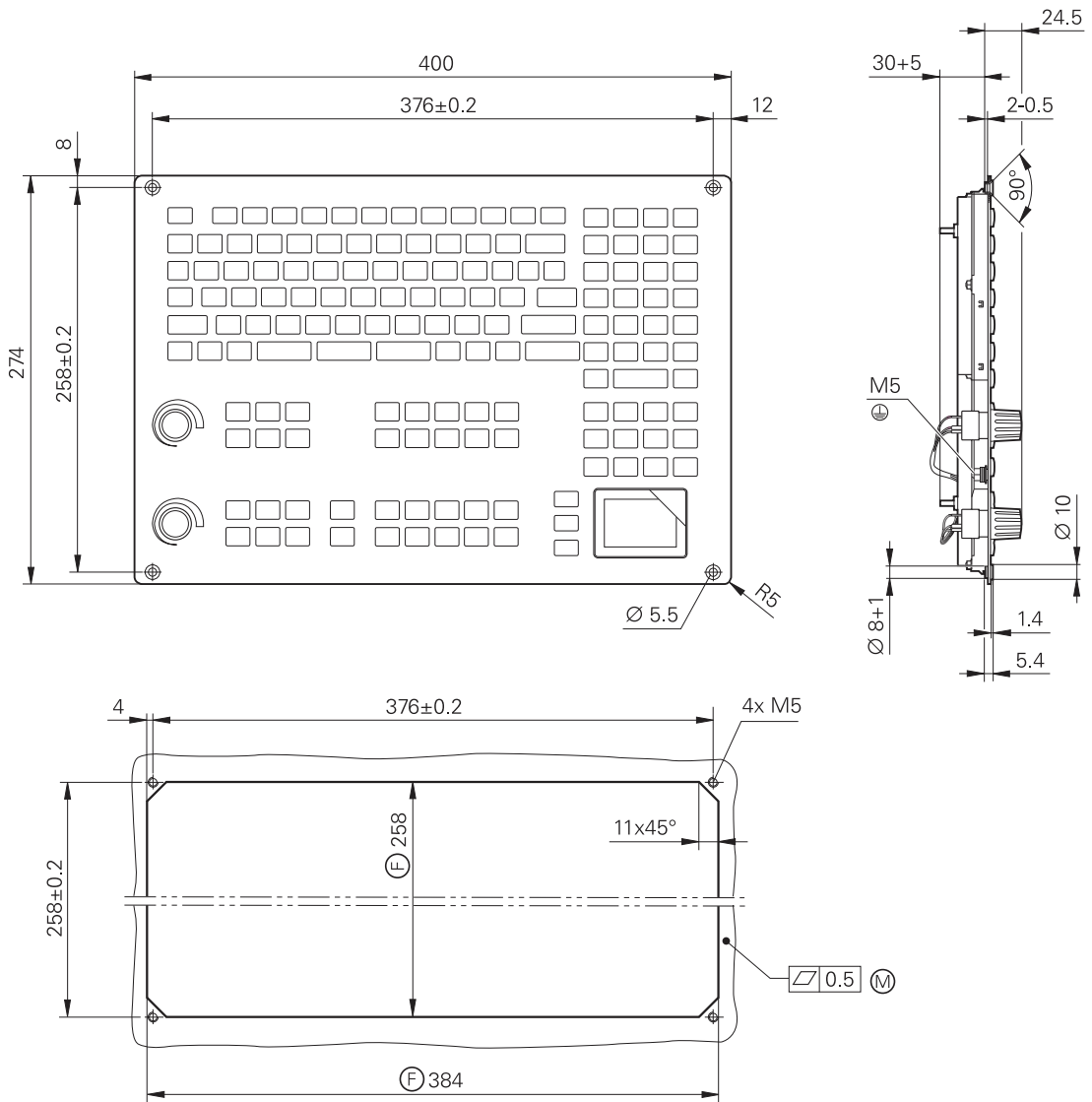

- ⊕ = Front panel opening
- Ⓜ = Mounting surface

TE 735, TE 735 FS

mm

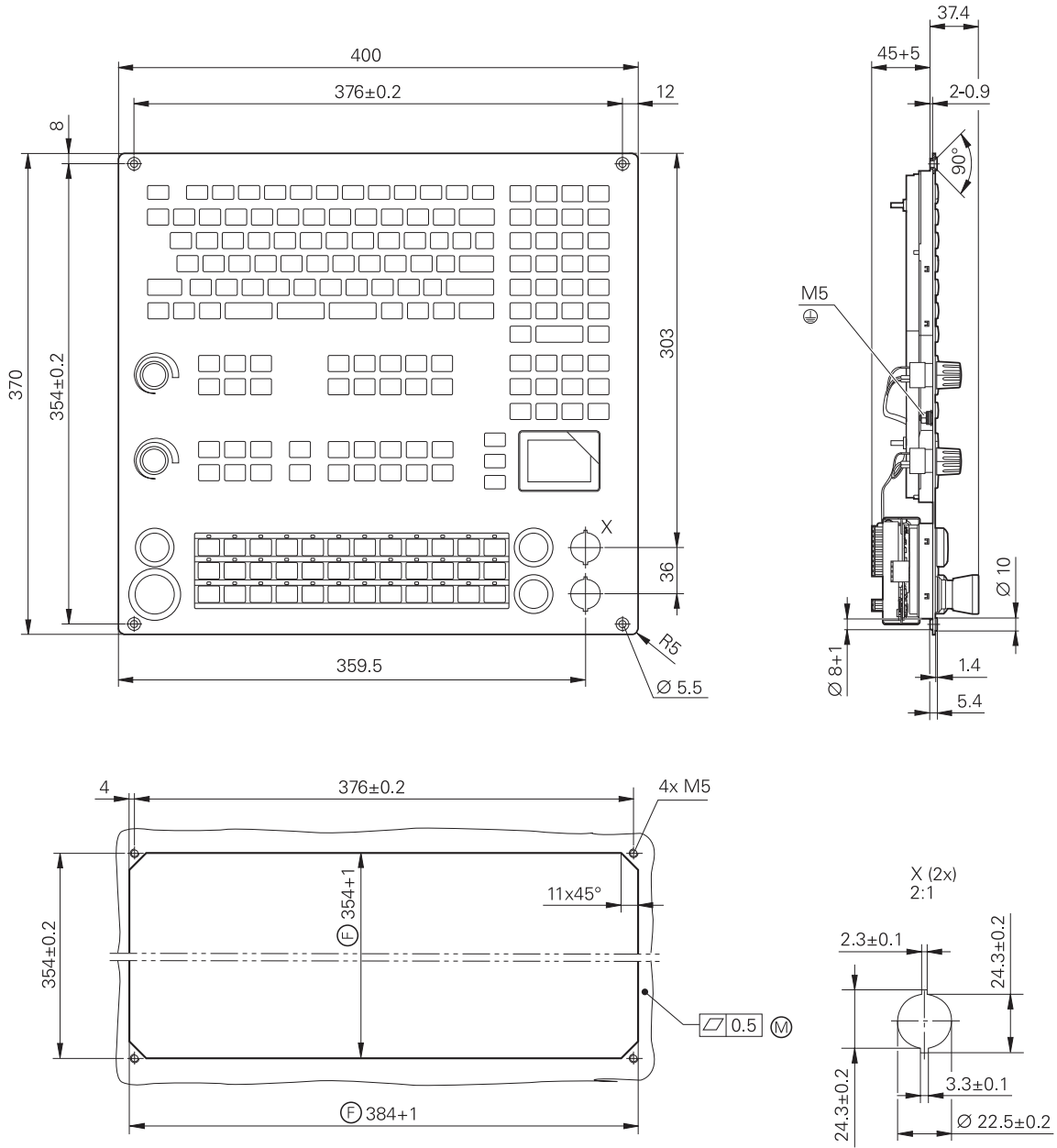
 Tolerancing ISO 8015
 ISO 2768 - m H
 < 6 mm: ±0.2 mm

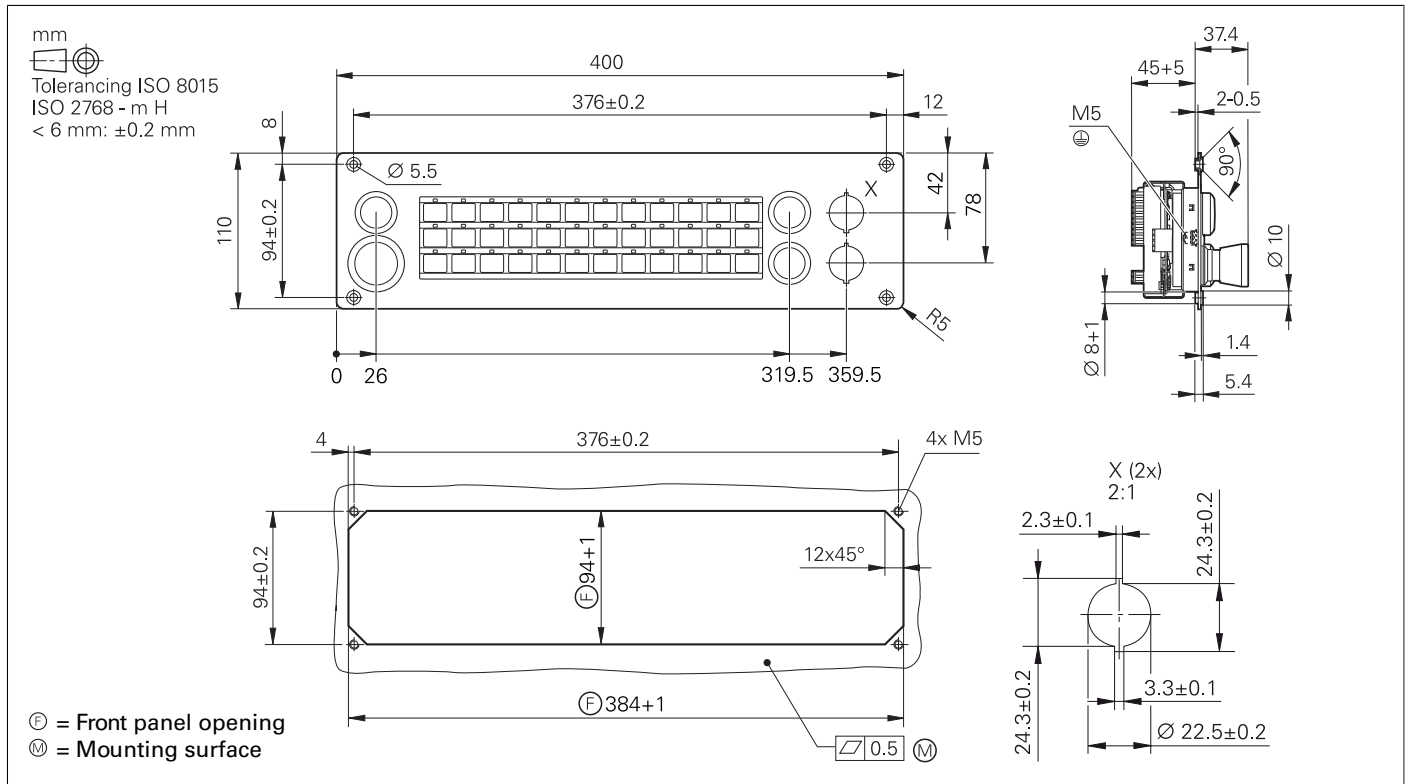

Ⓢ = Front panel opening
 Ⓜ = Mounting surface

MB 720, MB 720 FS



MB 721, MB 721 FS

mm

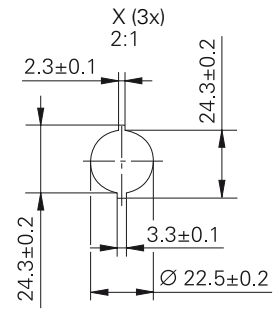
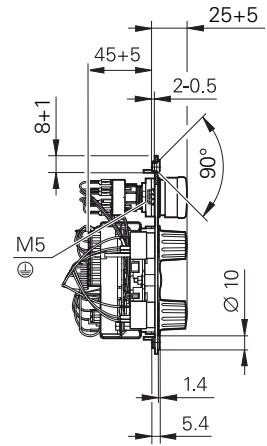
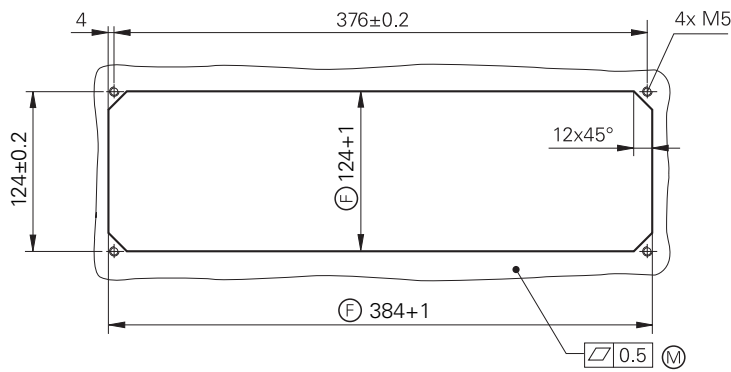
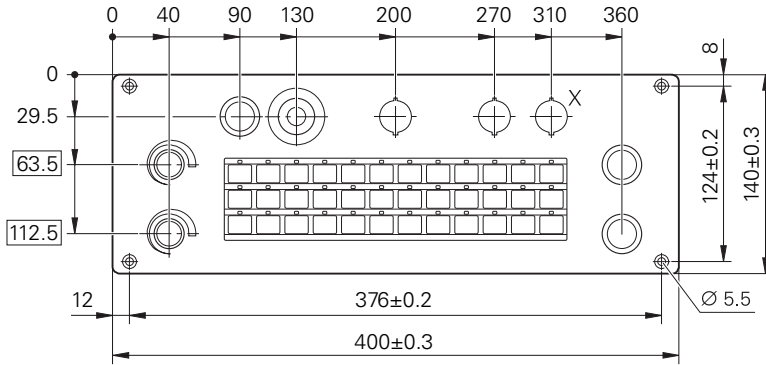
 Tolerancing ISO 8015
 ISO 2768 - m H
 < 6 mm: ±0.2 mm

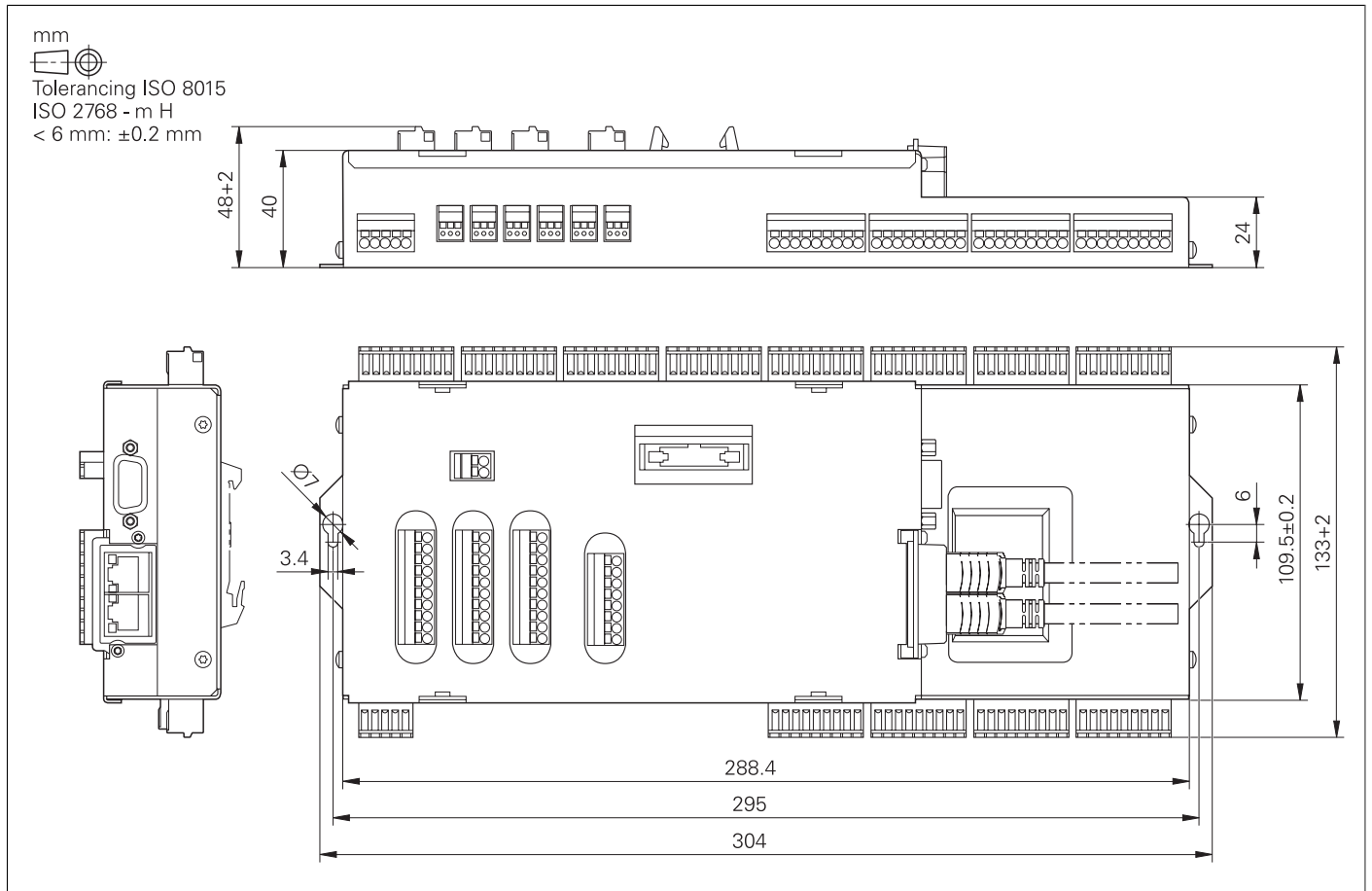

ⓕ = Front panel opening
 Ⓜ = Mounting surface

PLB 600x



PLC inputs and outputs

PL 6000 (PLB 62xx, PLB 61xx)

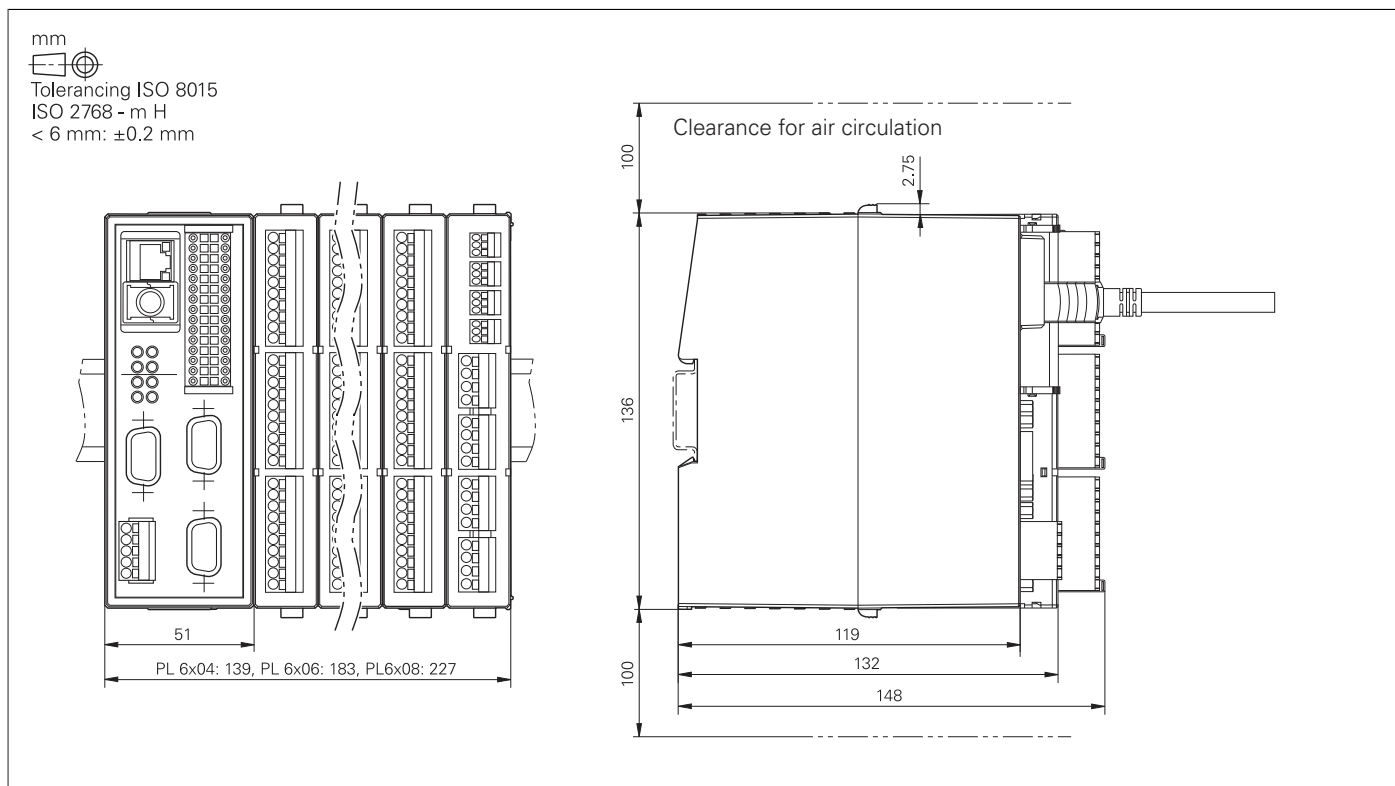

Power supply units

PSL 130

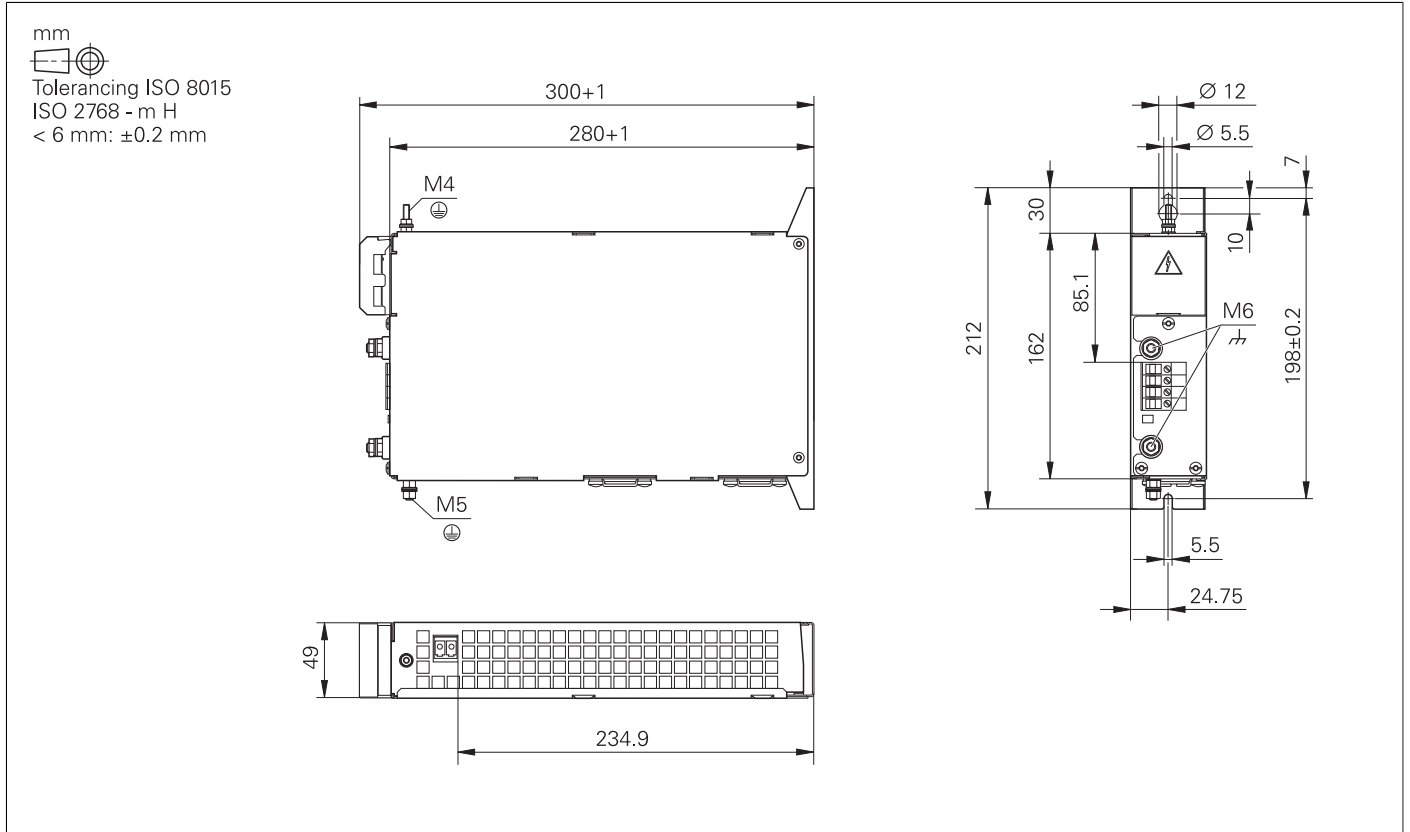

PSL 135

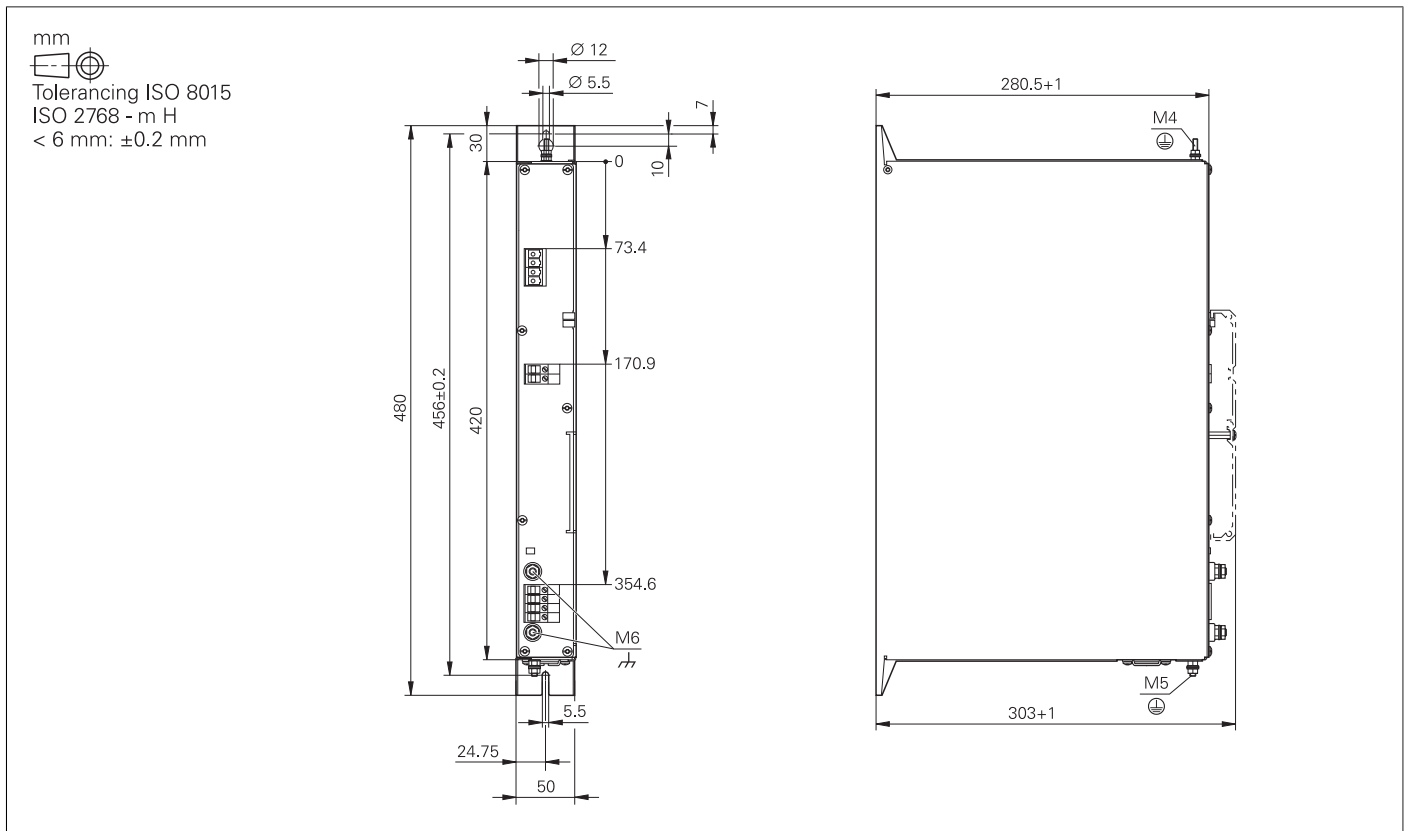

Electronic handwheels

HR 510, HR 510 FS

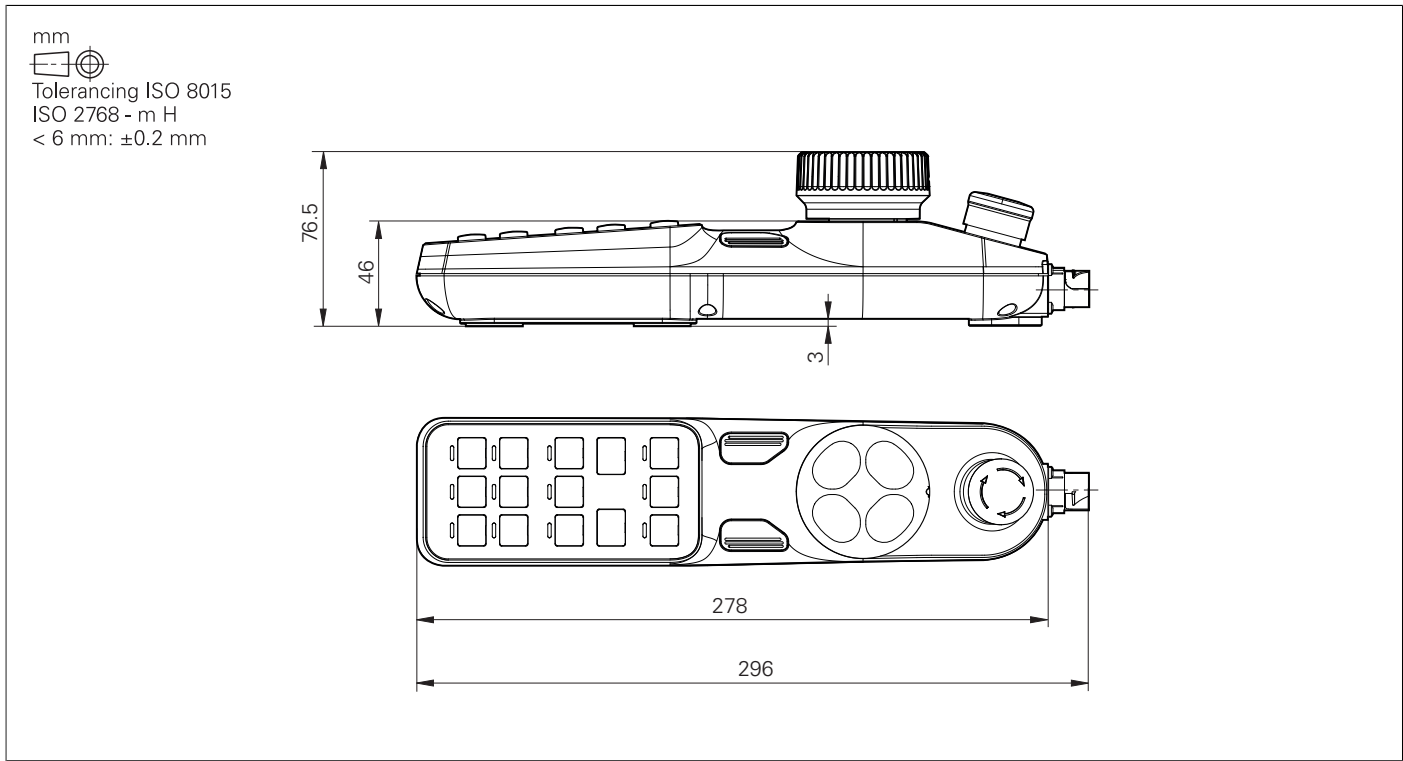

HR 520, HR 520 FS

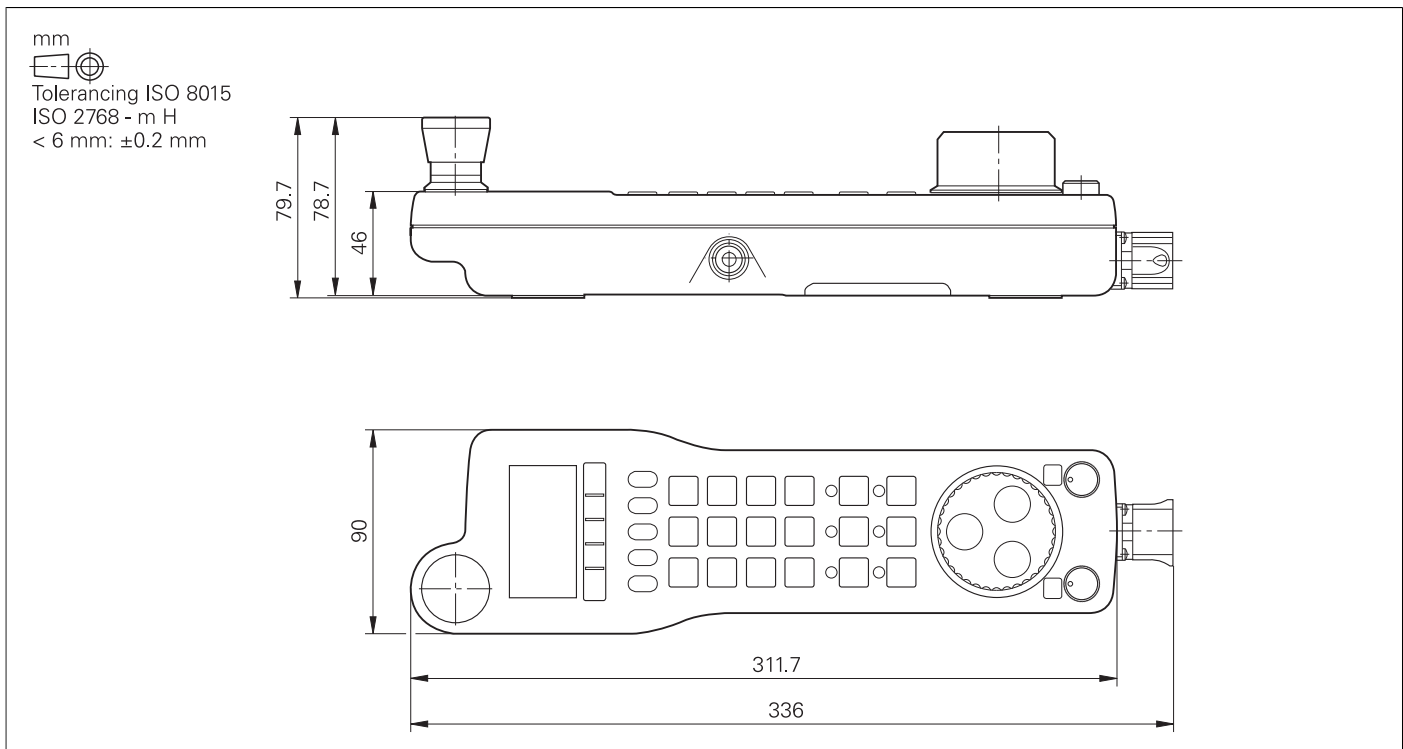

Holder for HR 520, HR 520 FS

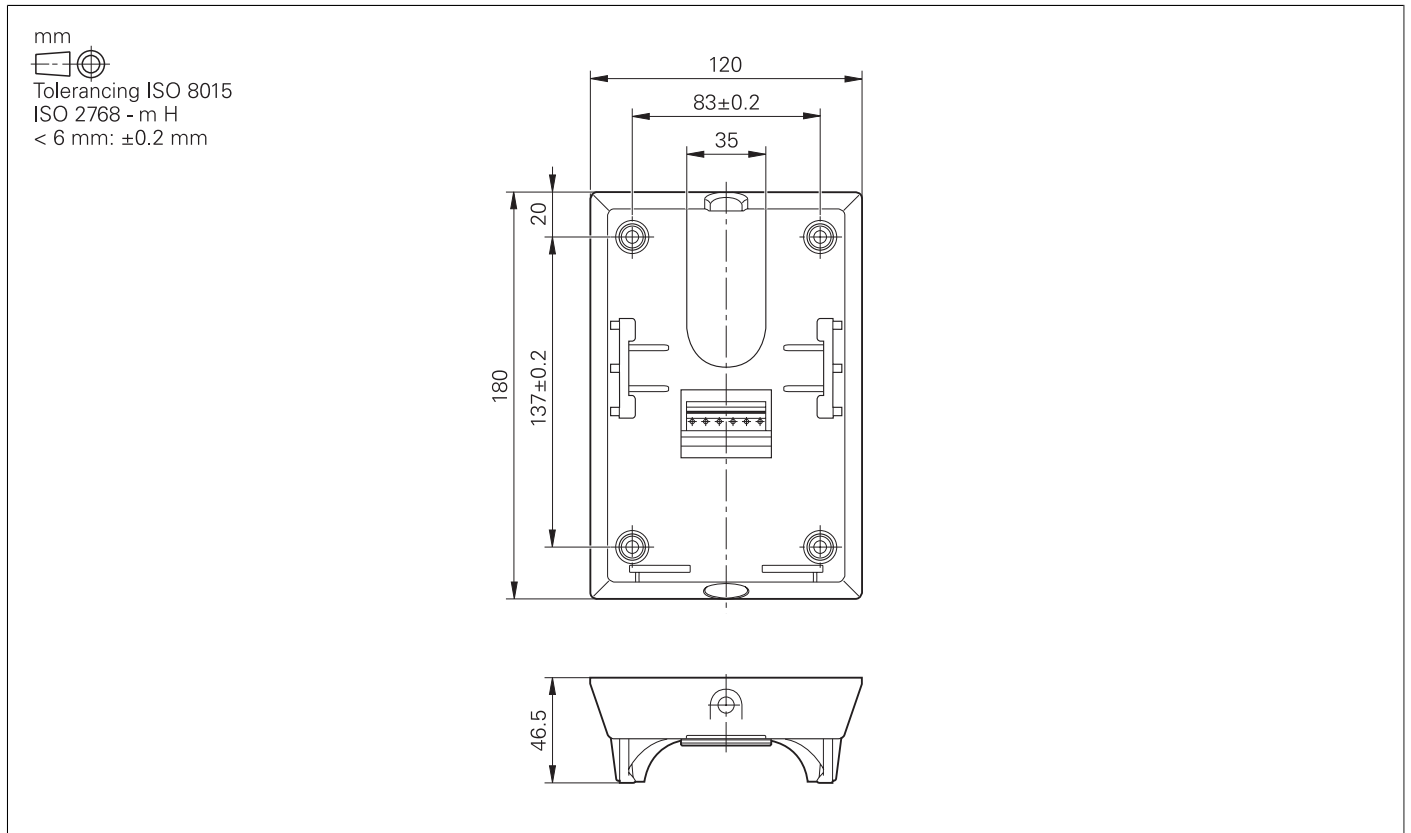

HR 550 FS

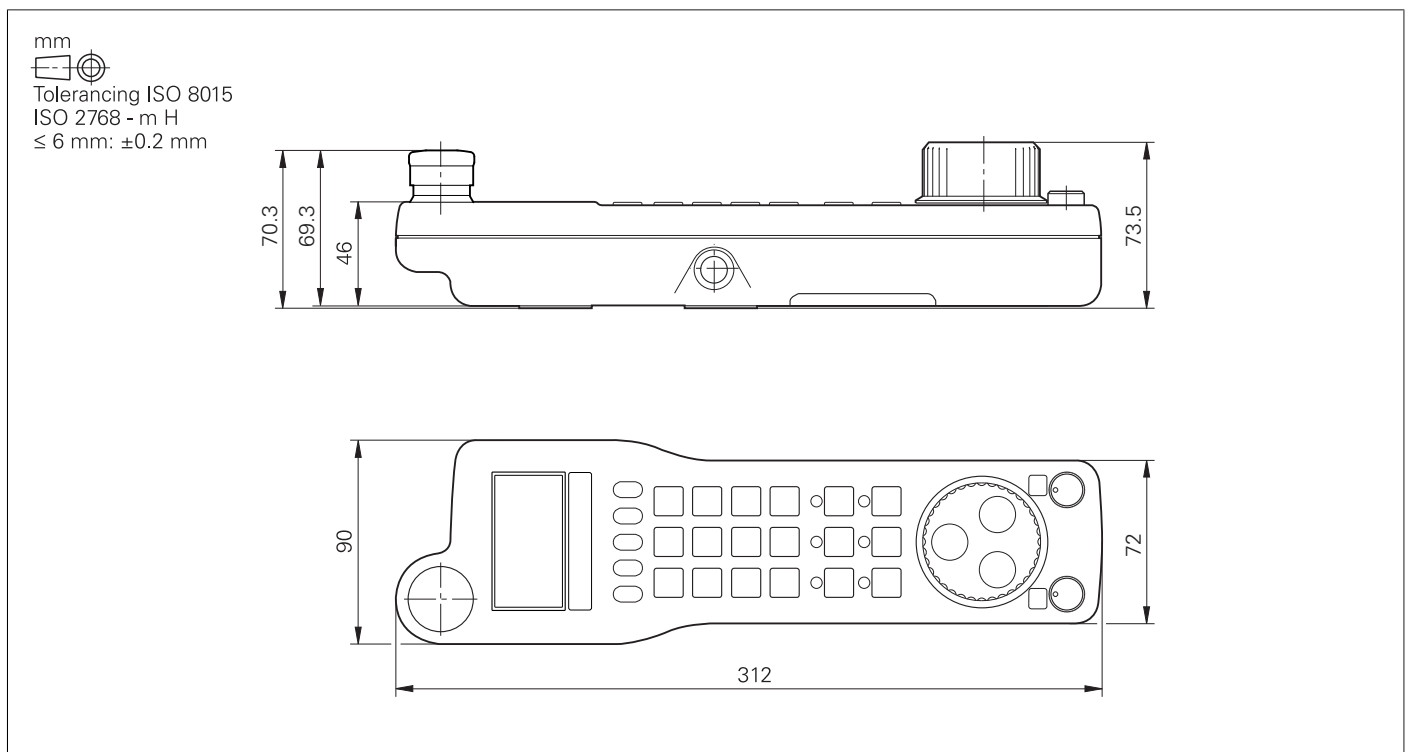

HRA 551 FS

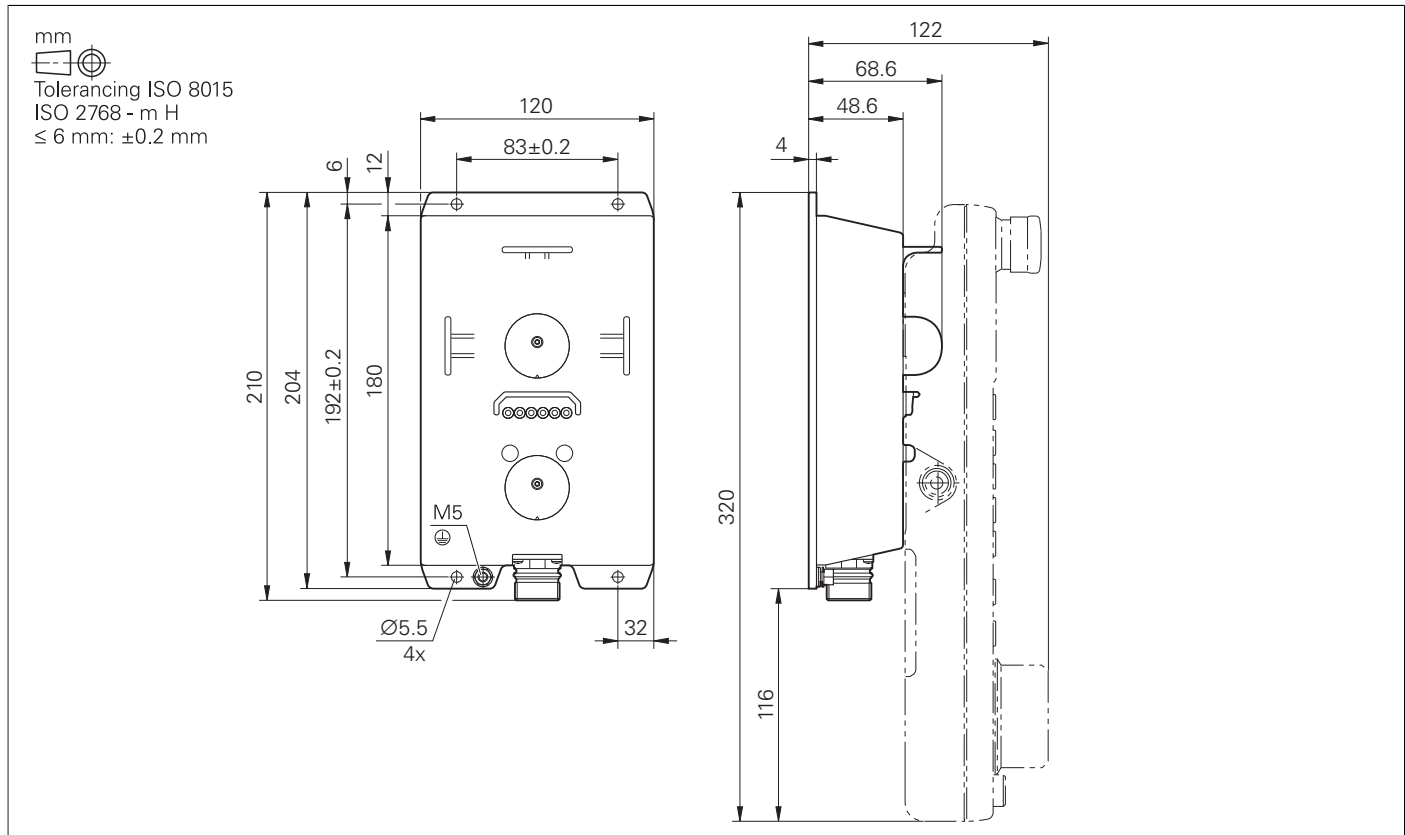

HR 130

mm



Tolerancing ISO 8015
ISO 2768 - m H
< 6 mm: ±0.2 mm

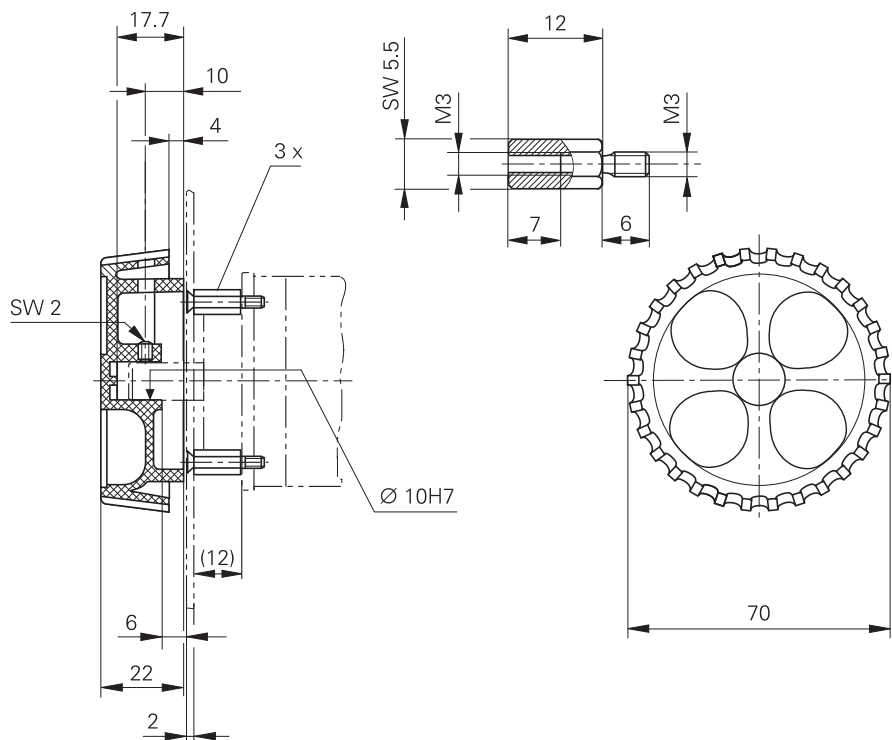
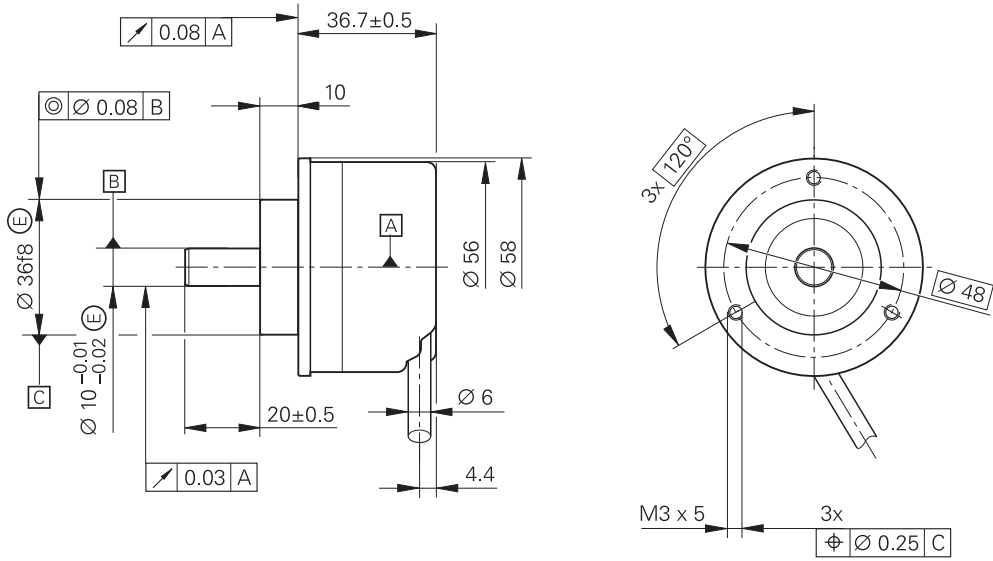

Adapter cable for handwheels (straight)

mm

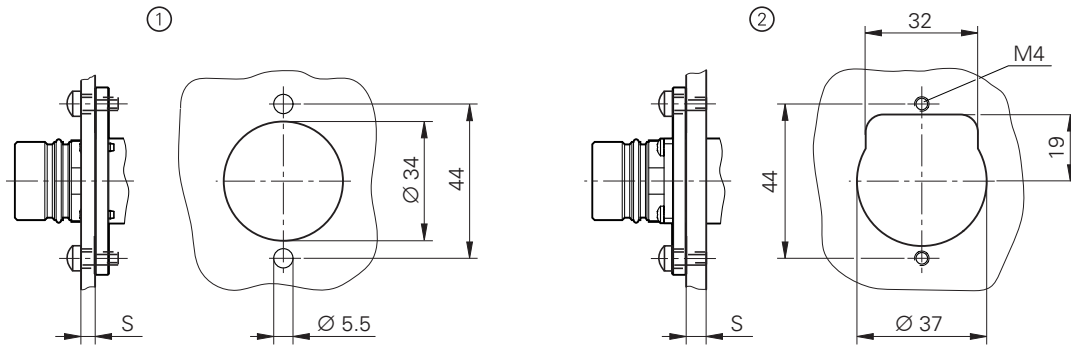
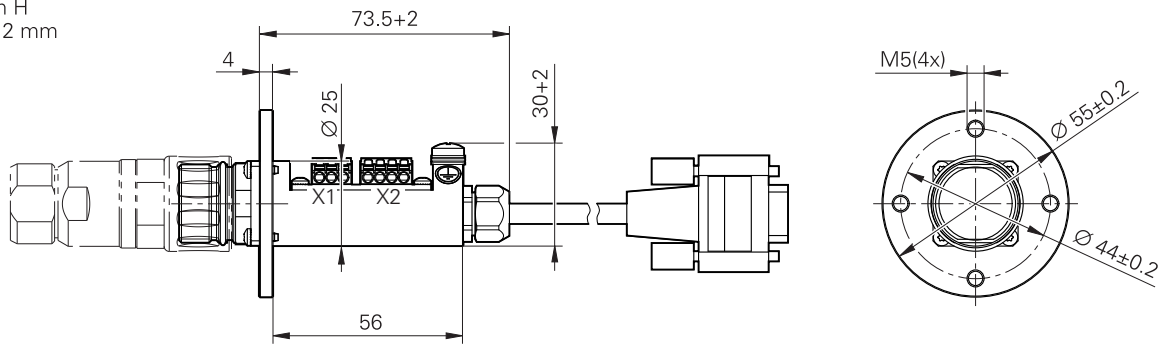
 Tolerancing ISO 8015
 ISO 2768 - m H
 < 6 mm: ±0.2 mm



- ① Mounting opening up to wall thickness $S = 4$
- ② Mounting opening for wall thickness $S = 4$ or more

HR/HRA adapter cable to MC (straight connector)

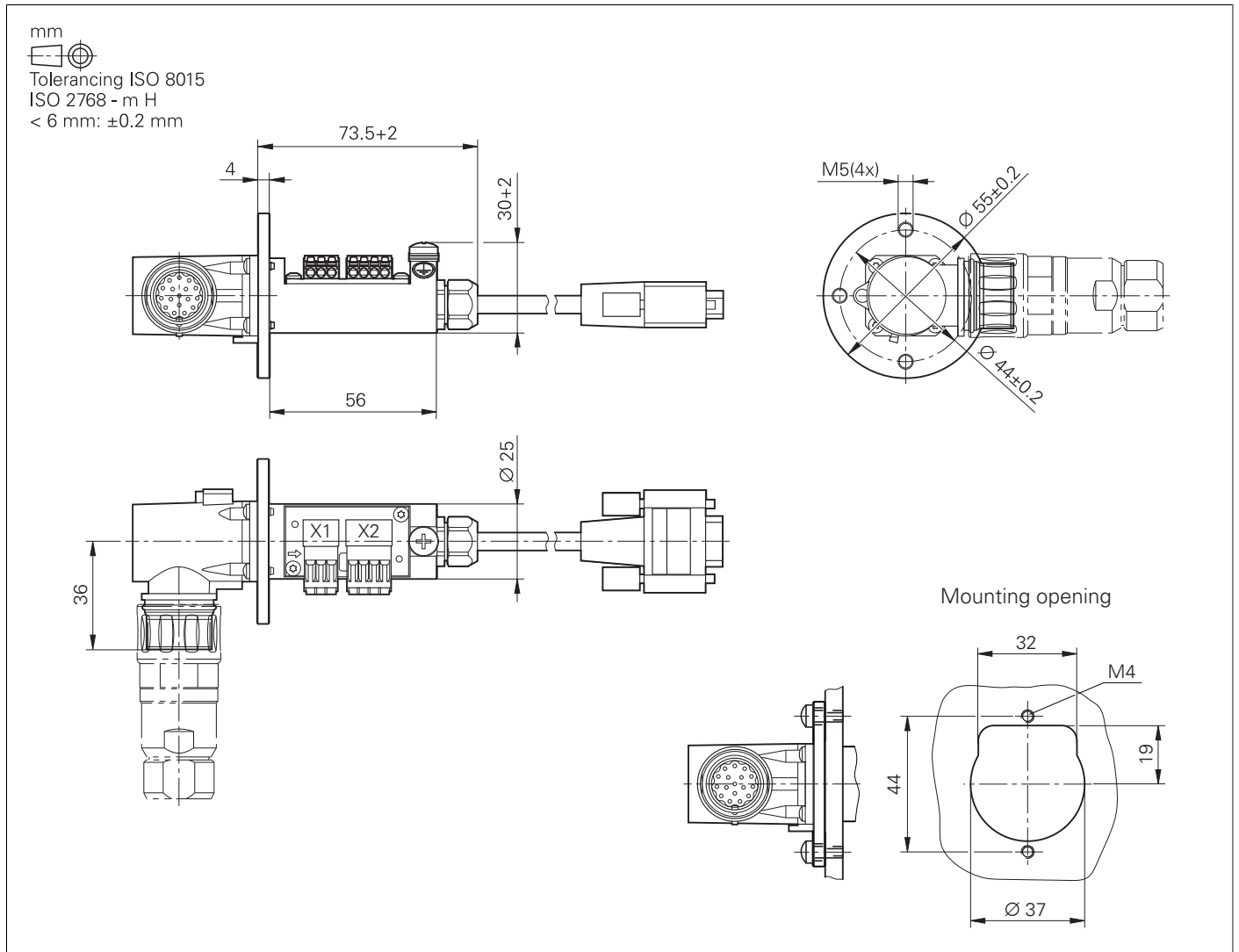
Adapter cable for handwheels (angled)



Adapter cable for HR/HRA to MC (angled connector)

Interface accessories

Line-drop compensator for encoders with EnDat interface

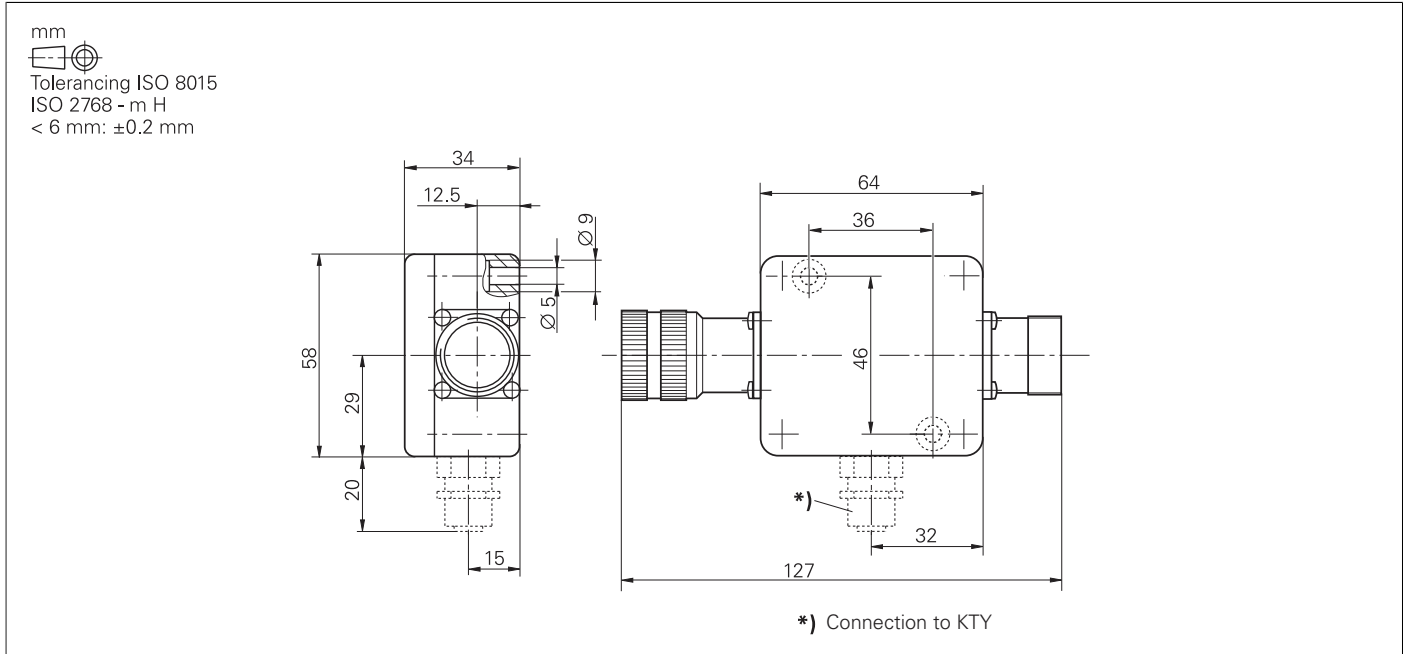

USB extension cable with hubs

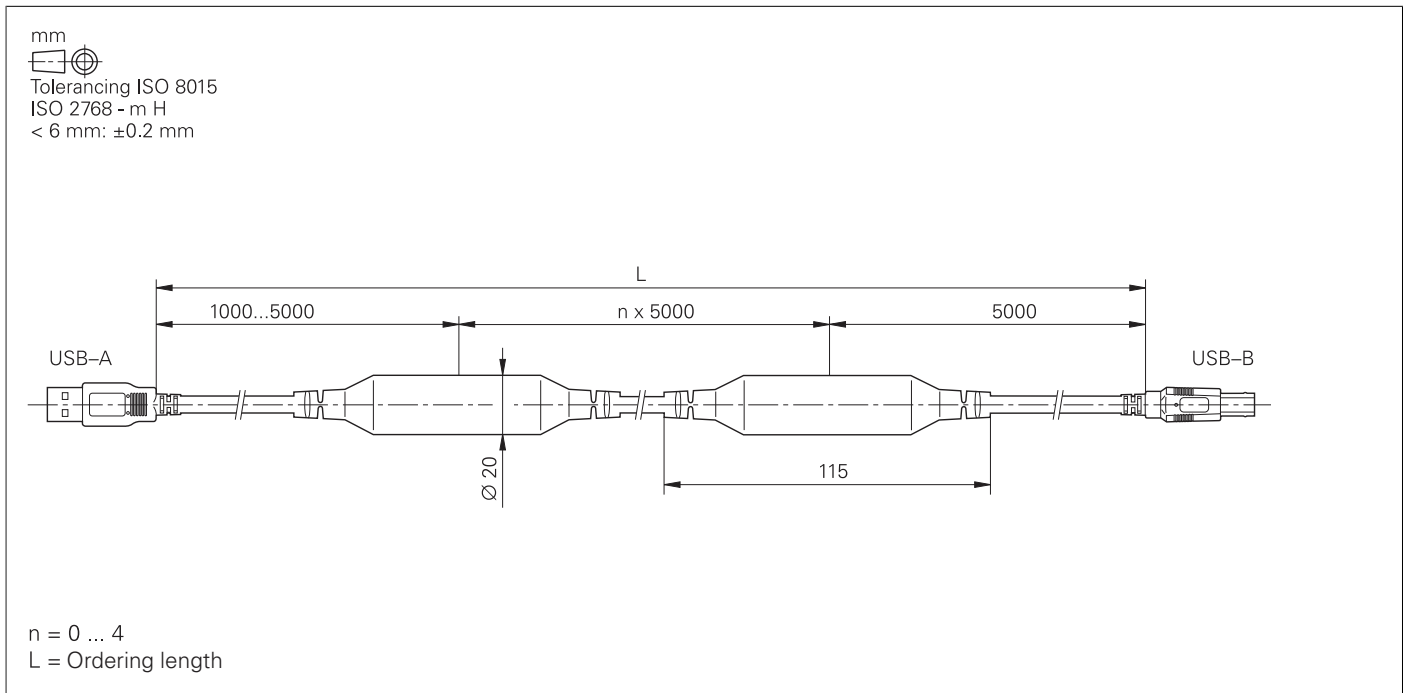

KTY adapter connector

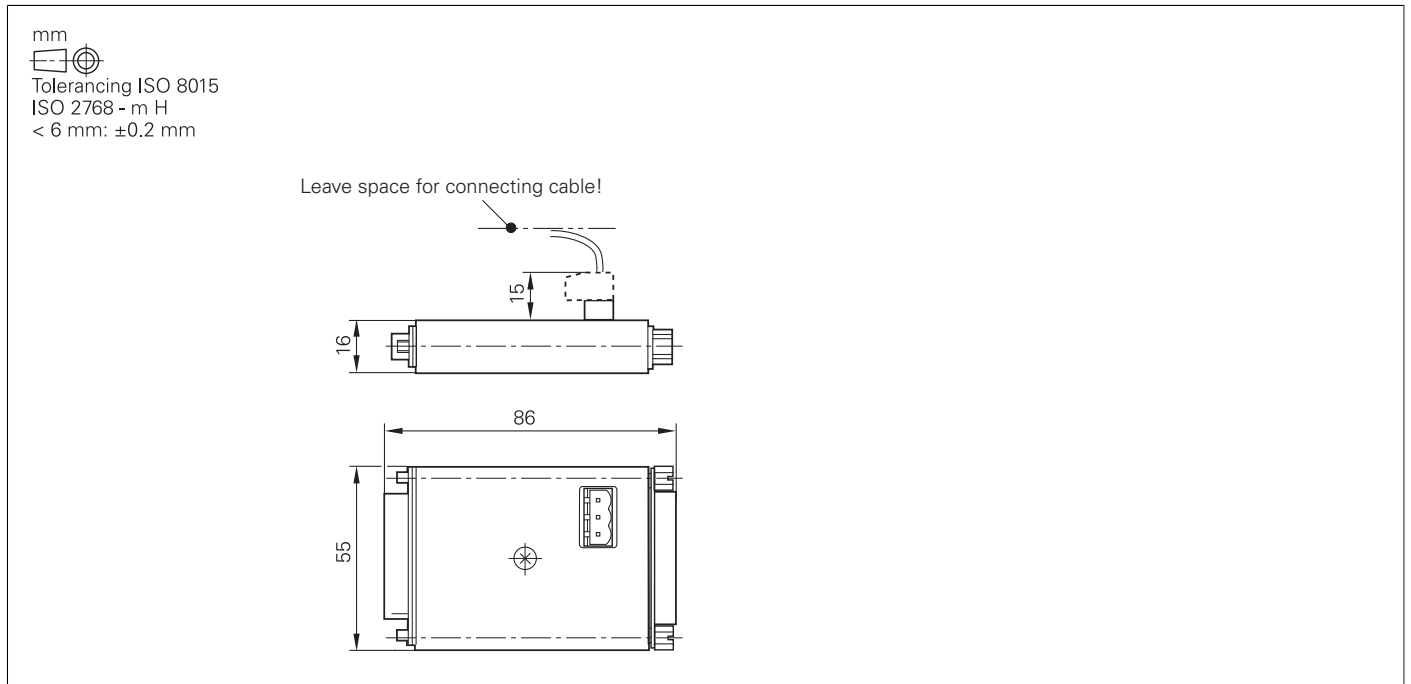

UTI 660

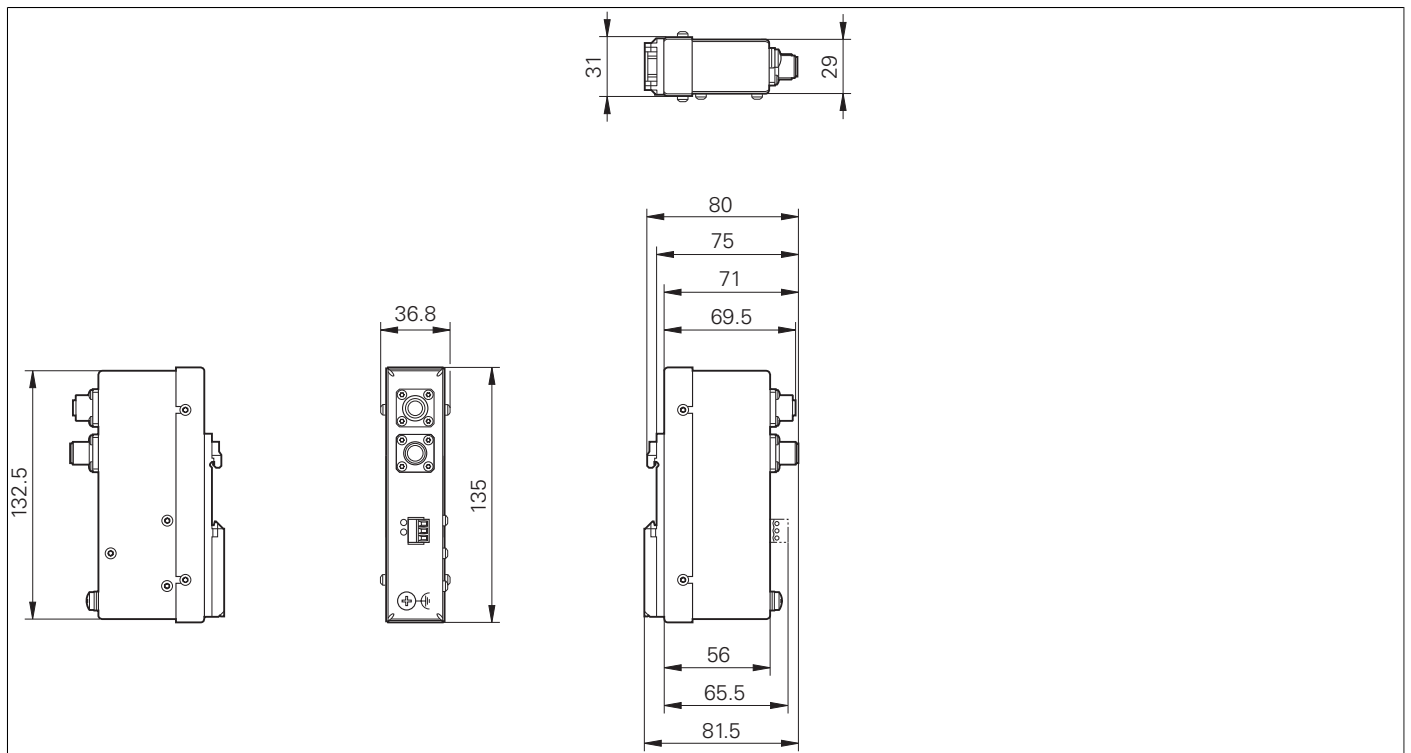

Camera system

VS 101

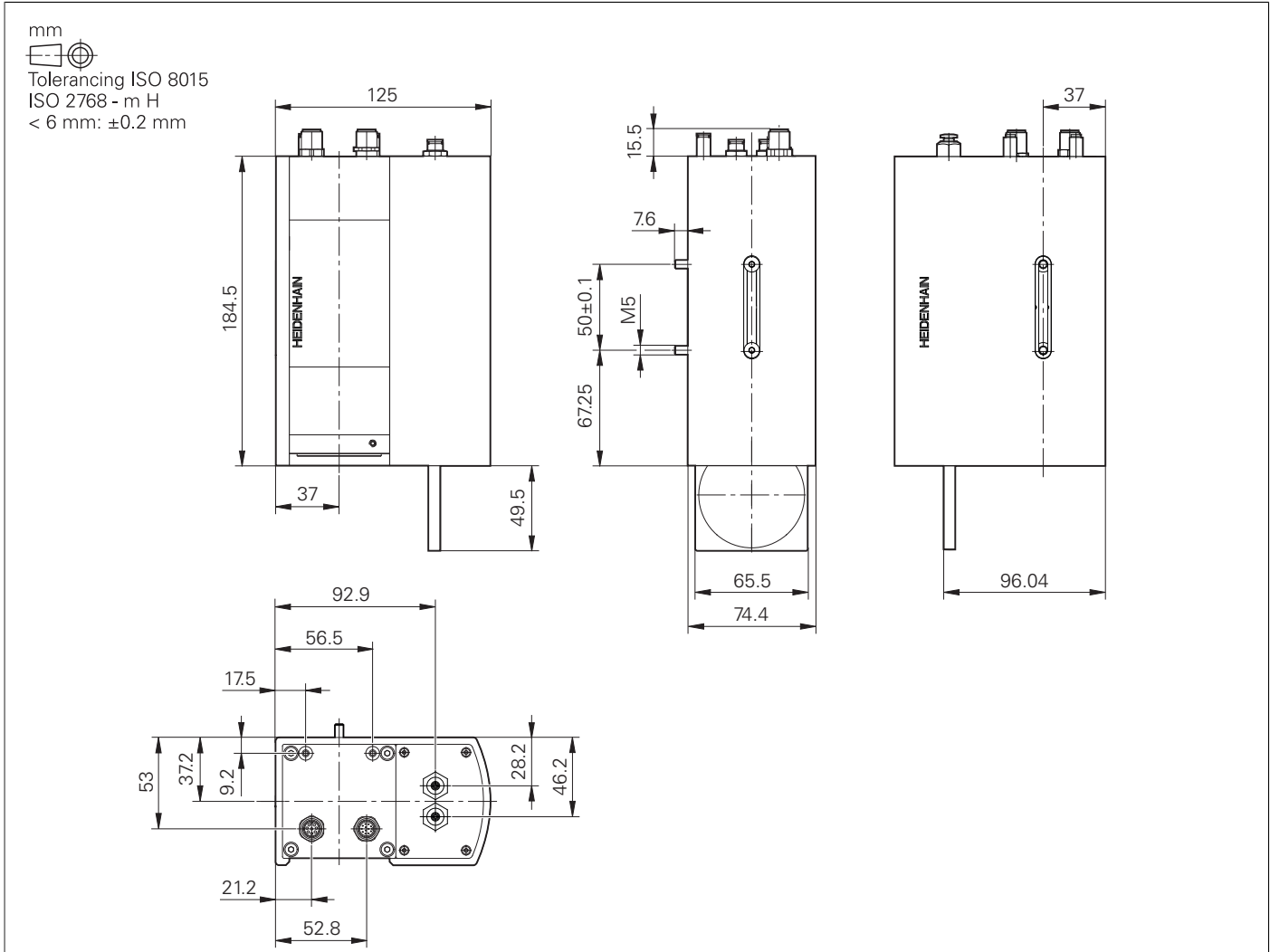

General information

Documentation

Technical documentation	Technical Manuals (PDF format on HESIS-Web including Filebase) <ul style="list-style-type: none">• TNC 640 ID 892899-xx• PNC 610 ID 1191125-xx• Inverter Systems and Motors ID 208962-xx• Functional Safety (FS) ID 749363-xx	
	Mounting Instructions <ul style="list-style-type: none">• TS 260 ID 808652-9x• TS 460 ID 808653-9x• TS 740 ID 632761-9x• TT 160 ID 808654-xx• TT 460 ID 808655-xx	
User documentation	User's Manuals <i>TNC 640</i> <ul style="list-style-type: none">• Klartext Conversational Programming ID 892903-xx• Setup, Testing, and Running NC Programs ID 1261174-xx• Cycle Programming ID 892905-xx• ISO Programming ID 892909-xx	
	<i>General</i> <ul style="list-style-type: none">• TNCremo Integrated help• TNCremoPlus Integrated help• PLCdesign Integrated help• CycleDesign Integrated help• IOconfig Integrated help• KinematicsDesign Integrated help• M3D converter Integrated help	
Other documentation	Brochures <ul style="list-style-type: none">• TNC 640 ID 892916-xx• Functions of the TNC 640 ID 1110731-xx• Touch Probes ID 1113984-xx• 1xx Inverter Systems ID 622420-xx• Motors ID 208893-xx• RemoTools SDK virtualTNC ID 628968-xx	
	Product Information documents <ul style="list-style-type: none">• HR 550FS PDF	
	Product Overviews <ul style="list-style-type: none">• Remote Diagnosis with TeleService ID 348236-xx	
	DVDs <ul style="list-style-type: none">• Touch Probes ID 344353-xx• Programming Station: TNC 640 (Demo Version) ID 1114029-xx	
	Technical Information documents <ul style="list-style-type: none">• Safety-Related Control Technology PDF• Safety-Related Position Encoders PDF• Uniformly Digital PDF	
	Safety parameters	For HEIDENHAIN products (such as control components, encoders, or motors), the safety characteristics (such as failure rates or statements on fault exclusion) are available on product-specific request from your HEIDENHAIN contact person.
	Basic circuit diagram	More information on basic circuit diagrams can be requested from your HEIDENHAIN contact person.

Service and training

Technical support HEIDENHAIN offers the machine manufacturer technical support to optimize the adaptation of the control to the machine, including on-site support.

Exchange control In the event of a malfunction, HEIDENHAIN guarantees the timely shipment of an exchange control (usually within 24 hours in Europe).

Helpline Our customer service technicians are available for questions regarding adaption or in the event of malfunctions:

NC support +49 8669 31-3101
(initial configuration/optimization, E-mail: service.nc-support@heidenhain.de
field service/troubleshooting)

PLC/Python programming +49 8669 31-3102
Functional safety (FS) E-mail: service.plc@heidenhain.de

NC/Cycle programming and kinematics +49 8669 31-3103
E-mail: service.nc-pgm@heidenhain.de

Encoders / machine calibration +49 8669 31-3104
E-mail: service.ms-support@heidenhain.de

Application programming +49 8669 31-3106
E-mail: service.app@heidenhain.de

If you have questions about repairs, spare parts, or exchange units, please contact our Service department:

Customer service, Germany +49 8669 31-3121
E-mail: service.order@heidenhain.de

Customer service, international +49 8669 31-3123
E-mail: service.order@heidenhain.de

Machine calibration On request, HEIDENHAIN engineers will calibrate your machine's geometry (e.g., with a KGM grid encoder).

Technical courses HEIDENHAIN provides technical customer training in the following subjects:

- NC programming
- PLC programming
- TNC optimization
- TNC servicing
- Encoder servicing
- Special training for specific customers

For more information on dates or registration:

Technical training courses in Germany	+49 8669 31-3049
	E-Mail: mtt@heidenhain.de
Technical training courses outside of Germany	www.heidenhain.de EN ► Company ► Contact ► HEIDENHAIN worldwide

Other HEIDENHAIN controls

Examples

TNC 620

Information:

TNC 620 brochure

- Compact contouring control for **milling, drilling, and boring machines**
- Axes: 8 control loops, up to two of which are configurable as spindles
- For operation with HEIDENHAIN inverter systems and ideally HEIDENHAIN motors
- Uniformly digital with HSCI interface and EnDat interface
- Compact size
- CompactFlash memory card
- Programming in HEIDENHAIN Klartext format or G-code (ISO)
- Standard milling, drilling, and boring cycles
- Touch probe cycles
- Short block processing time (1.5 ms)

Version with touchscreen:

- 19-inch screen (portrait), keyboard, and main computer in one unit (MC 8410)
- Integration of the keyboard in the lower screen area
- Multi-touch operation

Version with operating keys:

- Screen and main computer in one unit (MC 7420) and separate keyboard with integrated ASCII keys



CNC PILOT 640

Information:

CNC PILOT 640 brochure

- Contouring control for **lathes and turning-milling machines**
- Suitable for horizontal and vertical lathes as well as vertical boring and turning mills
- Axes: max. 24 control loops (22 control loops with functional safety (FS), max. 8 NC axes per channel, max. 6 spindles in the overall system)
- Multi-channel capability: up to 3 channels for asynchronous multi-slide machining
- Up to 3 principal axes (X, Z, and Y), B axis, closed-loop spindle and counter spindle, C1/C2 axis and driven tools
- 5-axis simultaneous machining (X, Z, Y, B, and C axes)
- Up to 3 programmable auxiliary axes (U, V, W) for control of steady rest, tailstock and counter spindle
- The position of a parallel secondary axis can be shown combined with its principal axis
- For operation with HEIDENHAIN inverter systems and preferably with HEIDENHAIN motors
- Uniformly digital with HSCI interface and EnDat interface
- 19-inch or 15.6-inch multi-touch display
- CFR CompactFlash memory card (CFast) with 8 GB
- Programming of turning, drilling, and milling operations with smart.Turn, according to DIN, or via cycles
- TURN PLUS for automated smart.Turn program generation
- ICP free contour programming for turning and milling contours
- For simple tool holders (multifix), turrets, or magazines



CNC PILOT 640
with 15.6-inch multi-touch display

Subject index

3			
3D-ToolComp.....	83		
5			
5-Axis Machining.....	64		
A			
Absolute encoders.....	70		
Accessories.....	5		
Active Chatter Control (ACC).....	75		
Active Vibration Damping (AVD).....	77		
Adapter connector for temperature sensor.....	26		
Adaptive Feed Control (AFC).....	74		
Additional modules.....	35		
Advanced Dynamic Prediction (ADP)....	73		
Advanced Function Set Turning.....	67		
API DATA.....	85		
Axes.....	63		
Axis clamping.....	72		
Axis feedback control.....	71		
B			
Backlash.....	81		
Basic modules.....	31		
Batch Process Manager (BPM).....	65		
BF 750.....	27		
BF 860.....	29, 108		
Bus diagnosis.....	86		
C			
Cable overview.....	51		
Calibration sphere.....	82		
Camera system.....	126		
CC 6106.....	22, 103		
CC 6108.....	22		
CC 6108, CC 6110.....	104		
CC 6110.....	22		
CC 61xx.....	22		
CMA-H 04-04-00.....	35		
Combined PROFIBUS DP/PROFINET IO module.....	35		
Commissioning and diagnostic aids.....	84		
Compensation of torque ripples.....	71		
Component Monitoring.....	80		
Components.....	4		
ConfigDesign.....	84		
Connected Machining.....	94		
Connecting cables.....	40		
Context-sensitive help.....	79		
Controller unit.....	21		
Control loop cycle times.....	72		
Control systems with external safety...	61		
Control systems with integrated functional safety (FS).....	59		
Crossover Position Filter (CPF).....	72		
Cross Talk Compensation (CTC).....	77		
Cycle times.....	21		
Cylinder Surface Interpolation.....	63		
D			
Data interfaces.....	92		
Degrees of protection.....	97		
Digital control design.....	57		
Digital servo control.....	71		
Display step.....	6		
DNC applications.....	94		
Double-speed.....	21		
Double Speed Control Loops.....	72		
DriveDiag.....	84		
Dynamic Collision Monitoring (DCM)....	79		
Dynamic Efficiency.....	74		
Dynamic Precision.....	76		
E			
Electromagnetic compatibility.....	97		
Electronic handwheels.....	38		
Encoder inputs.....	70		
EnDat 2.2.....	57		
Error compensation.....	81		
Ethernet.....	92		
Expansion PL.....	32		
Export version.....	16		
F			
Facing heads.....	67		
Facing slides.....	67		
Fast contour milling.....	73		
Feedforward control.....	71		
Fieldbus systems.....	35		
Following error.....	71		
G			
Gantry axes.....	64		
Gear Cutting.....	67		
Gear ranges.....	69		
Global Program Settings.....	65		
Grinding.....	68		
H			
HEROS 5.....	62		
HR 130.....	40, 121		
HR 510.....	38		
HR 510, HR 510 FS.....	118		
HR 510 FS.....	38		
HR 520.....	39		
HR 520, HR 520 FS.....	118		
HR 520 FS.....	39		
HR 550 FS.....	39, 119		
HRA 551 FS.....	39, 120		
HSCI.....	57		
HSCI adapter.....	34		
HSCI control components.....	16		
Hysteresis.....	81		
I			
I/O modules.....	32		
Incremental encoders.....	70		
Industrial PC.....	41		
Input resolution.....	6		
Installation elevation.....	97		
Integrated inverter.....	71		
Integrated PLC.....	87		
Interfacing to the machine.....	8		
Inverter system.....	53		
IOconfig.....	32		
IPC 6641.....	42, 98		
ITC 750.....	41, 110		
ITC 755.....	41, 107		
ITC 860.....	41, 108		
J			
Jerk.....	73		
Jerk limiting.....	73		
K			
Keyboard.....	27		
KinematicsComp.....	83		
KinematicsDesign.....	80		
L			
Linear axes.....	63		
Linear error.....	81		
Load Adaptive Control (LAC).....	76		
Log.....	85		
Look-ahead.....	73		
M			
M3D Converter.....	80		
Machine operating panel.....	27		
Main computer.....	16		
Master keyword.....	18		
Maximum spindle speed.....	69		
MB 720.....	28		
MB 720, MB 720 FS.....	113		
MB 720 FS.....	28		
MB 721.....	28		
MB 721, MB 721 FS.....	114		
MB 721 FS.....	28		
MC 366.....	17		
MC 6541.....	17, 98		
MC 6542.....	17		
MC 6542, IPC 6490.....	99		
MC 6641.....	17, 98		
MC 7522.....	17, 100		
MC 8512.....	17		
MC 8532.....	17, 102		
Module for analog axes.....	35		
Monitor.....	27		

Monitoring functions.....	78
Motion Adaptive Control (MAC).....	76
Mounting and electrical installation.....	97
Multiple main spindles.....	69

N

NC software license.....	19
Nonlinear error.....	81

O

Online Monitor.....	85
Operating system.....	62
Optimized Contour Milling (OCM).....	75
Oscilloscope.....	84

P

PL 6000.....	31, 116
PLA-H 08-04-04.....	32
PLB 600x.....	34, 115
PLB 6104.....	32
PLB 6104 FS.....	32
PLB 6106.....	32
PLB 6106 FS.....	32
PLB 6108.....	32
PLB 6108 FS.....	32
PLB 6204 EnDat.....	31
PLB 6204 FS EnDat.....	31
PLB 6206 EnDat.....	31
PLB 6206 FS EnDat.....	31
PLB 6208 EnDat.....	31
PLB 6208 FS EnDat.....	31
PLB 6210 EnDat.....	31
PLB 6210 FS EnDat.....	31
PLC axes.....	65, 88
PLC basic program.....	90
PLCdesign.....	88
PLC encryption.....	87
PLC inputs/outputs.....	87
PLC positioning.....	88
PLC programming.....	87
PLC soft keys.....	88
PLC window.....	88
PLD-H 04-04-00 FS.....	32
PLD-H 04-08-00 FS.....	32
PLD-H 08-04-00 FS.....	32
PLD-H 08-16-00.....	32
PLD-H 16-08-00.....	32
PNC 610.....	43
Position Adaptive Control (PAC).....	77
Position-controlled spindle.....	69
Power supply.....	16, 33
PROFIBUS DP module.....	35
PROFINET IO module.....	35
Proper minimum clearance.....	96
PSL 130.....	33, 117
PSL 135.....	33, 117
Python OEM Process.....	89

R

Real-Time Coupling Function.....	65
Remote Desktop Manager.....	94
RemoTools SDK.....	94
Reversal spikes.....	81
Ribbon cables.....	23
Rotary axes.....	63

S

Screen.....	27
SE 540.....	37
SE 642.....	37
SE 660.....	37
SE 661.....	37
SiK component.....	18
Single-speed.....	21
Sliding friction.....	81
Smoothed jerk.....	73
Snap-on keys.....	47, 49
Software.....	5
Software options.....	13
Specifications.....	6
Spindle.....	69
Spindle orientation.....	69
Spindle override.....	69
State Reporting.....	86
Static friction.....	81
Storage medium.....	18
Synchronized Axes.....	64
System PL with EnDat support.....	31

T

Table function.....	85
Tapping.....	69
TE 360.....	30, 30
TE 360 FS.....	30, 30
TE 730.....	27
TE 735.....	27
TE 735, TE 735 FS.....	112
TE 735 FS.....	27
TE 745.....	29
TE 745, TE 745 FS.....	109
TE 745 FS.....	29
TeleService.....	86
Thermal expansion.....	81
Tilting the Working Plane.....	64
TNCalyzer.....	86
TNCkeygen.....	19
TNCopt.....	85
TNCremo.....	93
TNCremoPlus.....	93
TNCscope.....	85
TNCtest.....	86
Tool measurement.....	37
Torque Control.....	64, 64
Touch probes.....	36
Trace function.....	85
Transceiver.....	37

U

UEC 111.....	24, 105
UEC 112.....	24, 105
UEC 113.....	24, 105
UEC 11x.....	23
UMC 111 FS.....	25, 106
UMC 11x FS.....	25
USB.....	92
User administration.....	62
UTI 660.....	37

V

V.24/RS-232-C protocols.....	92
virtualTNC.....	94
Visual Setup Control (VSC).....	80
VS 101.....	46, 126

W

Workpiece measurement.....	36
----------------------------	----

HEIDENHAIN

Mastering nanometer accuracy



HEIDENHAIN

DR. JOHANNES HEIDENHAIN GmbH

Dr.-Johannes-Heidenhain-Straße 5

83301 Traunreut, Germany

☎ +49 8669 31-0

☎ +49 8669 32-5061

✉ info@heidenhain.de

www.heidenhain.com

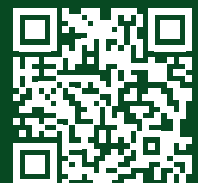

HEIDENHAIN
worldwide